

THRIVING ON INNOVATION  
**LAGUNA TOOLS**



**LT14 SUV Series Bandsaw Manual**

17101 Murphy Avenue, Irvine , Ca 92614 Toll Free: 800.234.1976

**Dear Woodworker:**

**Thank you for your purchase and welcome to the Laguna Tools group of discriminating woodworkers. I understand that you have a choice of where to purchase your machines and appreciate the confidence you have in our products.**

**Every machine sold by Laguna Tools has been carefully designed and well thought through from a woodworker's perspective. I cut on our bandsaws, lathes, table saws and combination machines. Through my hands-on experience, I work hard to make our machines better. I strive to give you machines that inspire you to create works of art. Machines that are a joy to run and work on. Machines that encourage your performance.**

**Today, we offer high-performance machines with innovative solutions that meet the needs of woodworkers and their ever-evolving craft.**

**I started Laguna Tools as a woodworker; I still am.**

**Thank you again for becoming a Laguna Tools customer.**

**Torben Helshoj**

**President and Founder – Laguna Tools**

**Thriving on Innovation**

## Table of contents

	<b>Page number</b>
<b>Safety Rules</b>	<b>4</b>
<b>Warranty</b>	<b>5</b>
<b>Noise emission</b>	<b>6</b>
<b>Specification sheet</b>	<b>6</b>
<b>Receiving your machine</b>	<b>7</b>
<b>Introduction to your machine</b>	<b>7</b>
<b>What you will receive with the machine</b>	<b>8</b>
<b>Parts of the bandsaw</b>	<b>10</b>
<b>Where to locate your machine</b>	<b>12</b>
<b>Unpacking your machine</b>	<b>13</b>
<b>Assembly and setup</b>	<b>14</b>
<b>Adjusting the bandsaw</b>	<b>22</b>
<b>Using the bandsaw</b>	<b>31</b>
<b>Maintenance and troubleshooting</b>	<b>41</b>
<b>Electrical drawing</b>	<b>46</b>
<b>Exploded view drawings</b>	<b>47</b>

### **Safety Rules:**

**As with all machinery, there are certain hazards involved with the operation and use of your new machine. Using it with caution will considerably lessen the possibility of personal injury. However, if normal safety precautions are overlooked or ignored, personal injury to the operator may result. If you have any questions relative to the installation and operation, do not use the equipment until you have contacted your supplying distributor.**

**Read carefully before operating the machine:**

- 1. Keep the working area clean and be sure adequate lighting is available.**
- 2. Do not wear loose clothing, gloves, bracelets, necklaces or ornaments. Wear face, eye, respiratory and body protection devices as indicated for the operation or environment.**
- 3. Be sure that the power is disconnected from the machine before tools are serviced or an attachment is to be fitted or removed.**
- 4. Never leave the machine with the power on.**
- 5. Do not use dull, gummy or cracked cutting tools.**
- 6. Be sure that the keys and adjusting wrenches have been removed and all the nuts and bolts are secured.**

## LIMITED WARRANTY

New woodworking machines sold by Laguna Tools carry a one-year warranty effective from the date of shipping. Laguna Tools guarantees all new machine sold to be free of manufacturers' defective workmanship, parts and materials. We will repair or replace, without charge, any parts determined by Laguna Tools, Inc. to be a manufacturer's defect. We require that the defective item/part be returned to Laguna Tools with the complaint. In the event the item/part is determined to be damaged due to lack of maintenance, cleaning or misuse/abuse, the customer will be responsible for the cost to replace the item/part, plus all related shipping charges. This limited warranty does not apply to natural disasters, acts of terrorism, normal wear and tear, product failure due to lack of maintenance or cleaning, damage caused by accident, neglect, lack of or inadequate dust collection, misuse/abuse or damage caused where repair or alterations have been made or attempted by others.

Laguna Tools, Inc. is not responsible for additional tools or modifications sold or performed (other than from/by Laguna Tools, Inc.) on any Laguna Tools, Inc. woodworking machine. Warranty maybe voided upon the addition of such described tools and/or modifications, determined on a case-by-case basis.

Normal user alignment, adjustment, tuning and machine settings are not covered by this warranty. It is the responsibility of the user to understand basic woodworking machinery settings and procedures and to properly maintain the equipment in accordance with the standards provided by the manufacturer.

Parts, under warranty, are shipped at Laguna Tools, Inc.'s cost either by common carrier, FEDEX ground service or a similar method. Technical support to install replacement parts is primarily provided by phone, fax, e-mail or Laguna Tools Customer Support Website. The labor required to install replacement parts is the responsibility of the user.

Laguna Tools is not responsible for damage or loss caused by a freight company or other circumstances not in our control. All claims for loss or damaged goods must be notified to Laguna Tools within twenty-four hours of delivery. Please contact our Customer Service Department for more information.

Only new machines sold to the original owner are covered by this warranty. For warranty repair information, call 1-800-332-4094.

Copyright 2010 Laguna Tools, Inc

\*\* Warning – no portion of these materials may be reproduced without written approval from Laguna Tools, Inc.

### **Noise Emission**

Notes concerning noise emission: Given that there exists a relationship between noise level and exposure times, it is not precise enough to determine the need for supplementary precautions. The factors affecting the true level of exposure to operators are clearly the amount of time exposed, the characteristics of the working environment, other sources of dust and noise, etc. For example, adjacent machines impact the level of ambient noise. It is possible that exposure level limits will vary from country to country.

### **Specification sheet**

	<b>LT14 X 14 SUV</b>
<b>Motor</b>	<b>3hp Leeson 220 V 1 ph</b>
<b>Throat</b>	<b>13.25"</b>
<b>Table</b>	<b>Cast iron 15" x 15"</b>
<b>Miter slot</b>	<b>2x "T" slots</b>
<b>Table height</b>	<b>35.5"</b>
<b>Foot brake</b>	<b>Yes with micro switch</b>
<b>Rack and pinion upper guide</b>	<b>Yes</b>
<b>Rack &amp; pinion table tilt</b>	<b>Yes</b>
<b>Fly wheel</b>	<b>Cast iron 14" diameter</b>
<b>Resaw Capacity</b>	<b>14"</b>
<b>Minimum Blade</b>	<b>1/16"</b>
<b>Maximum blade</b>	<b>1"</b>
<b>Mobility kit</b>	<b>Optional</b>
<b>Dust Ports</b>	<b>4" x 2</b>
<b>Guides</b>	<b>Laguna guides</b>
<b>Blade quick release</b>	<b>Yes</b>
<b>Blade length</b>	<b>125"</b>
<b>Height</b>	<b>70"</b>
<b>Weight</b>	<b>380 Lbs , shipping 420 Lbs</b>

## **Receiving your machine**

**Note:** It is probable that your machine will be delivered by a third party. Before you unpack your new machine, you will need to first inspect the packing, invoice and shipping documents supplied by the driver. Ensure that there is no visible damage to the packing or the machine. You need to do this prior to the driver leaving. All damage must be noted on the delivery documents and signed by you and the delivery driver. You must then contact the seller within 24 hours.

## **Introduction to Bandsaws**

This bandsaw is designed to give you years of safe service. Read this owner's manual in its entirety before assembly or use. The bandsaw is generally defined as a saw blade in the form of an endless steel band that rotates around two or more wheels. This blade is a continuous metal band with teeth on one side. As the wheels rotate, so does the band, which creates the continuous sawing action. Because the direction of the blade is always downward toward the table, there is little danger (except for special cuts) that the wood will be thrown back at the operator, which is called a kickback. There is always danger of kickback when a circular saw is being used.

For safety reasons many woodworkers prefer the bandsaw, especially when cutting small pieces. The unique feature of the bandsaw is that the work piece can be rotated around the blade, creating a curve. It is the tool most often used when curves have to be cut in wood. Because the bandsaw blade is fairly thin, it can cut thick stock with a minimum of horsepower. For this reason the bandsaw is often used when valuable pieces of wood are made into a thin piece of veneer.

**What you will receive with the bandsaw.**

**Note.** Some parts shown below are options and may not be supplied with the machine.



**Main table**



**Mobility handle**



**Rip fence**



**Mobility axle and wheels**



**Spring assistor**

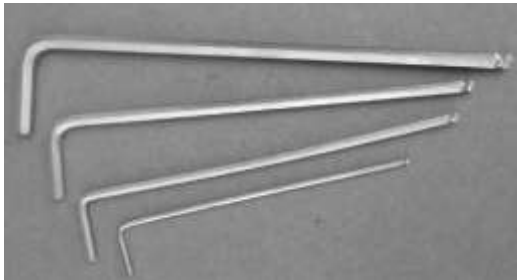




**Screws, etc.**



**Leveling bolts**



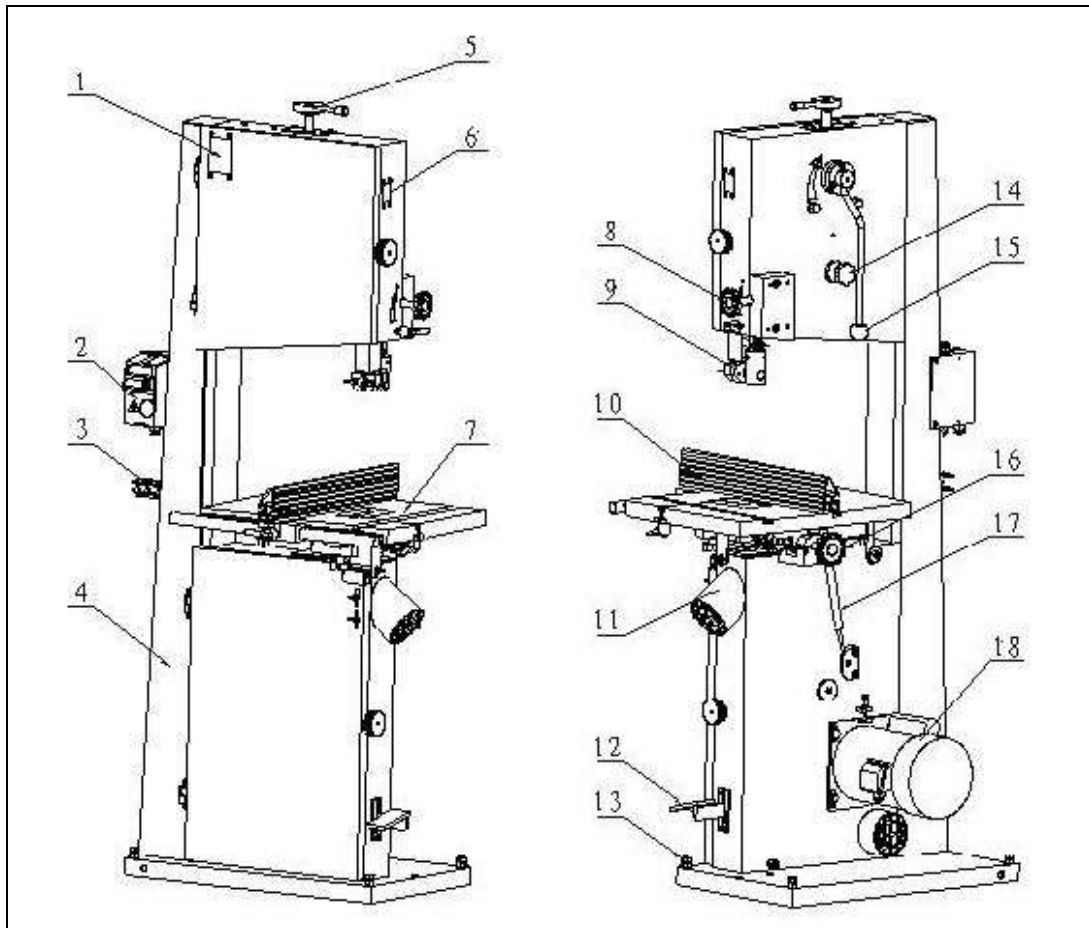
**Allen keys**



**Tool holder**



**Mobility bracket**



1. Tension Indicator Window	10. Rip Fence Assembly
2. Magnetic Switch	11. Upper Dust Port 4”
3. Tool Storage Hooks	12. Foot Brake
4. Frame	13. Mounting Bolt
5. Blade Tension Lever	14. Blade Tracking Knob
6. Blade Tracking Window	15. Quick Release Blade Tension Lever
7. Iron Table	16. Table Tilt Knob
8. Blade Guide Adjustment Hand Wheel	17. Supporting Spring Assembly
9. Blade Guide	18. Motor

**Parts of the Bandsaw**

The bandsaw does not have many parts. The major parts are discussed in this manual. If you are not familiar with the bandsaw, take the time to read this section and become familiar with the machine.

**Flywheel**

The blade is suspended over two wheels that are covered with a rubber tire. The tire cushions the blade and protects the teeth from coming in contact with the metal of the flywheel. The lower wheel is the drive wheel and is attached to the motor with a drive belt. The lower flywheel powers the blade and pulls the blade down through the work piece. The top wheel has two functions. One function is to balance or track the blade on the wheels, and the second one is to tension the blade. Both functions are adjustable.

**Body**

The body of the bandsaw is a U-shaped frame that houses all the parts of the machine. This is the heart of the bandsaw and has to be very rigid, as it takes the strain of the blade being tensioned.

**Table**

The table supports the work piece and can tilt to produce cuts at various angles. It has a groove to the right-hand side of the blade, which is used to guide the miter gauge. In the center is a table insert that the blade passes through. Should the blade wander off center, this table insert will protect the blade from damage, as it is soft and will not damage the blade. The table also supports the adjustable fence, which is used for parallel cuts. There is an aligning pin or nut and screw, which joins both sides of the table and stops the table from warping. The pin or nut and screw must always be fitted in the table and only removed when removing or fitting a blade.

**Blade guides**

There are two sets of blade guides, one above and one below the table. The function of the guides is to give the blade stability and ensure that the blade movement left/right, forward/back is kept to a minimum. The guides above the table are fitted to a shaft that

has vertical adjustment. The upper guides are adjustable so that the guides are held just above the job being cut. This gives the blade the maximum amount of stability and also keeps the amount of blade that is exposed to a minimum. If you are using blades narrower than 1/4", there is available an optional cool block guide system.

### **Guards**

When running, the blade can be very dangerous, and the amount of blade that is exposed must be kept to a minimum. The machine is supplied with a number of guards, all of which **MUST** be installed and used while the machine is running. There is a guard that is attached to the lower door and is adjustable vertically once the door is closed. There is a guard on the guide vertical adjustment shaft. The guard is only removed to install or remove the blade.

### **Drive**

The drive (power) is supplied to the machine by an electric motor located at the back of the machine. It powers the lower flywheel through a rubber drive belt and is controlled by switches that are mounted on the frame vertical post at the front of the machine.

### **Electrical connection**

This is achieved by connecting the electrical supply to a switch/terminal box located on the side of the machine. A cable is provided, but you will need to have a suitable plug fitted to suit your electrical system. Never connect directly to the electrical motor, and all electrical connections must be conducted by a qualified electrician. For detailed instructions see the

### **Brake**

The machine is supplied with a foot brake. It is located close to the ground on the right-hand side of the machine. It has two functions. First, to remove the power to the motor, which is achieved with a switch that is mounted on the body of the machine. The second function is to slow the lower flywheel; this is achieved by applying a brake pad to the flywheel. The more pressure that is applied, the faster the flywheel slows.

### **Dust collection.**

The bandsaw produces a lot of sawdust, so extraction is very important. This is achieved by connecting dust extraction hoses to the dust ports located at the back of the machine and the right-hand side of the machine, below the table with a minimum capacity of 1,000 CFM. The stronger the suction from the dust collector, the better for you and the machine.

## **Identification**

There is a plate at the back of the machine listing all the manufacturing data, including the serial number, model, blade length, etc.

## **Tension scale**

Tension scales are designed to indicate the compression of a spring. As a rule, the greater the spring compression, the greater the tension on the blade. The tension scale does not register until the blade is relatively taut and is located on the inside of the body vertical post. The tension scale is a general reference and not a rule.



**Serial and data plate**

## **Tilt and Tension Mechanism**

The upper wheel is attached to the tilt and tension mechanism. This mechanism adjusts the wheel so that the bandsaw blade can be adjusted for tracking. This is achieved by a screwed handle at the back of the machine that pushes on the mechanism and adjusts the axis of the wheel so that it runs true with the lower wheel. The second function is to tension the blade, which is achieved by adjusting the upper flywheel vertically. A handle is located at the top of the bandsaw and, when rotated, will move the wheel up or down. The machine has a quick-acting blade release mechanism, which is located at the back of the machine and will remove the tension from the blade to speed the removal and fitting of blades. The mechanism has a spring that helps to keep the tension constant as the blade expands and contracts with the heat generated by the cutting action.

## **Fence**

The fence is located to the left of the blade and is used to assist in parallel cuts. It is adjustable for the drift of the blade and also the thickness of the cut.

## **Where to locate your machine.**

Before you remove your bandsaw from the pallet, select the area where you will use your machine. There are no hard-and-fast rules for its location, but below are a few guidelines.

1. There should be an area at the front and back of the machine suitable for the length of wood that you will be cutting. If you intend to use your saw for scrollwork, this may not be important but should be considered at this stage.
2. Adequate lighting. The better the lighting, the more accurate and safely you will be able to work
3. Solid floor. You should select a solid flat floor, preferably concrete or something similar.
4. Close to power source and dust collection.

## Unpacking your machine.

To unpack your machine, you will need tin snips, knife and a wrench.

1. Using the tin snips, cut the banding that is securing the machine to the pallet.

**WARNING: EXTREME CAUTION MUST BE USED BECAUSE THE BANDING WILL SPRING AND COULD CAUSE INJURY.**

1. Lift the box off and discard.

2. Using the knife, cut the plastic wrap from the top. The table, motor, fence and accessories that were ordered could be attached to the side of the machine, and extreme caution must be taken so that the parts

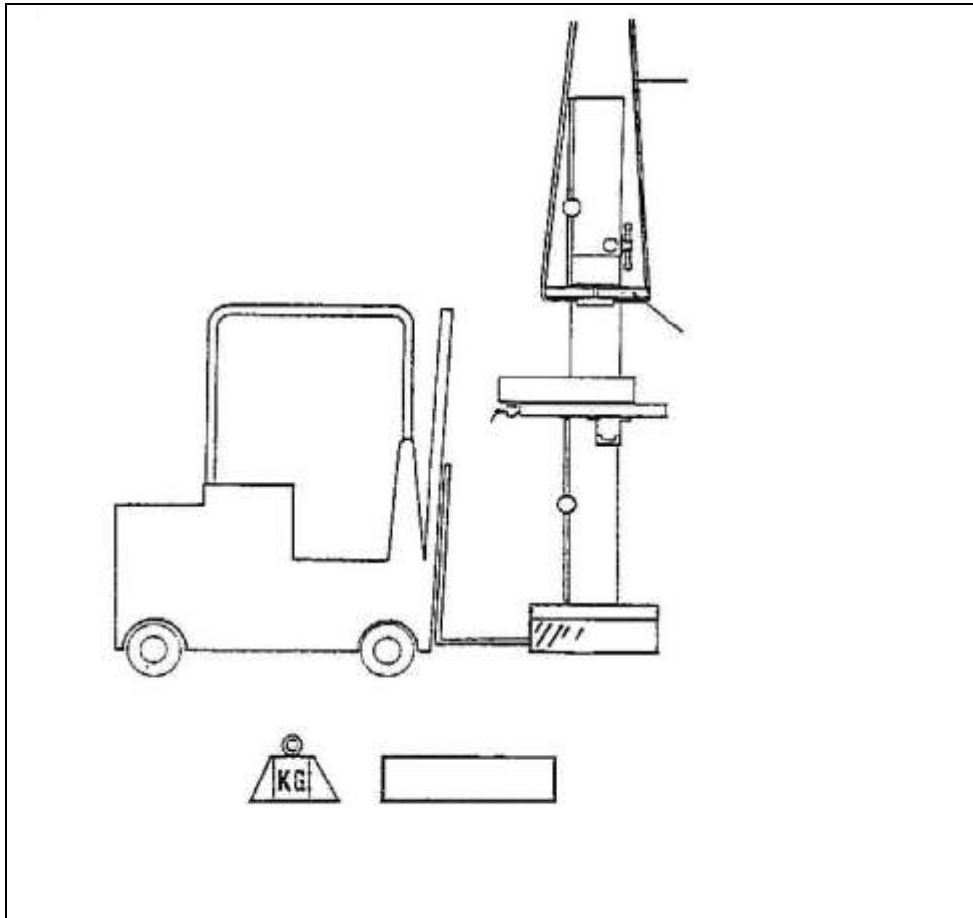
do not fall and cause injury or damage. Remove them in order from the top and set aside.

3. Place the motor on the pallet behind the machine. Ensure that there is no tension on the motor wiring. It is recommended that the motor be assembled to the bandsaw prior to removing the bandsaw from the pallet (see mounting motor). If you decide to remove the bandsaw prior to assembling the motor to the bandsaw, ensure that there is no tension on the motor wiring at any stage of the operation.

4. Remove the base mounting bolts that secure the machine to the pallet.

5. It is recommended that the machine be removed from the pallet by lifting it with a hoist or forklift. Place a sling through the bandsaw as shown below and lift vertically. Remove the pallet and lower to the floor. The machine can be lifted by using a forklift truck by sliding it onto the forks or by using a forklift "sling," as shown with a minimum lifting capability of 2,000 kg (440lbs).





If no lifting device is available, the machine can be removed from the pallet as follows:

**Note:** The machine is heavy, and if you have any doubt about the described procedure, seek professional assistance. Do not attempt any procedure that you feel is unsafe or that you do not have the physical capability of achieving. With two or more people, move the machine so that the base of the bandsaw is over the edge of the pallet. Tilt the bandsaw away from the pallet so that the base of the machine touches the floor. Slide the pallet from under the machine and then move the bandsaw to the vertical position so that it is completely resting on the floor.

### **Assembly & Setup**

#### **Mounting the Motor**

Two people are required to assemble the motor to the bandsaw; build up wooden blocks to the right height to rest the motor on. One person holds the motor in position, and the other will fit the drive belt and the bolts.

1. Attach the motor mounting plate to the motor with the four bolts provided.

2. Assemble the motor to the back of the bandsaw after the drive belt has been attached to the motor pulley and is located in the drive groove in the fly wheel.

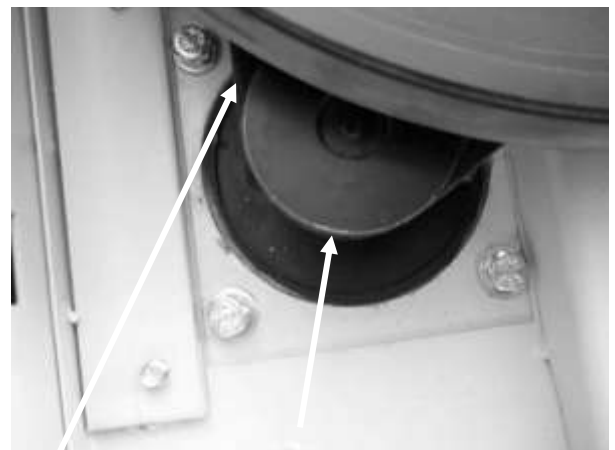


**Motor with mounting flange fitted**

**Belt tensioning bolt**



3. Once the belt is mounted on both the pulley V grooves, and the mounting bolts are a snug fit but not fully tightened, apply tension by adjusting the tensioning bolt. Tension is 3/16" deflection when using your thumb on one side of the belt. If the tension is too tight, you will experience motor strain; if it is too loose, you will experience belt slippage and lack of power. Once the correct tension has been achieved, fully tighten the mounting bolts. After a few hours of operation, it is necessary to check that the tension is correct, as the belts will bed into the V grooves. As a guide, the belt should have the same tension/deflection as the fan or alternator belt on your car.



**Belt**

**Motor pulley**

### **Mobility Kit (optional)**

If you have purchased a mobility kit or it is supplied standard with your machine, now is the ideal time to fit it, as the table has not been fitted to the machine, and the bandsaw is lighter; however, the mobility kit can be fitted later if you require it.

### **Mobility kit assembly procedure**

1. Rest the bandsaw on a 2" x 4" wood block or something similar.
2. Fit the shaft through the base of the bandsaw.
3. Fit the wheels, washers and split pins as shown on both sides of the base.
4. Place a wooden spacer under the machine and then fit the front bracket as shown.



**Mobility kit fitted**



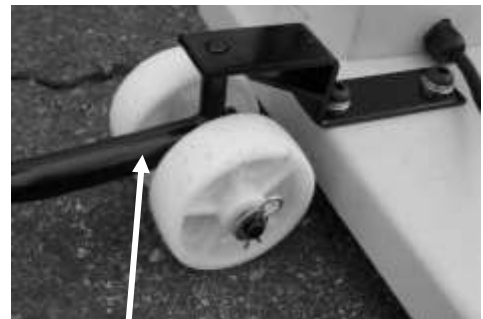
**Rear axle and wheel**



**Front leveling bolt**



**Mobility front bracket**



**Mobility handle**

### **Leveling Bolts**

If you are fitting a mobility kit, you will only need to fit two bolts at the front of the machine. If you decide not to fit the mobility kit or have not purchased one, then you will have to fit



leveling bolts at all four corners of the machine.

1. Raise the machine off the ground onto wooden blocks.
2. Fit a bolt as shown to either two or four corners of the machine, depending on if you fit the mobility kit.
3. Lower the machine to the ground and place a spirit level on the column of the machine.
4. Adjust the bolts until the spirit level shows that the column is vertical in both planes and the machine will not rock.

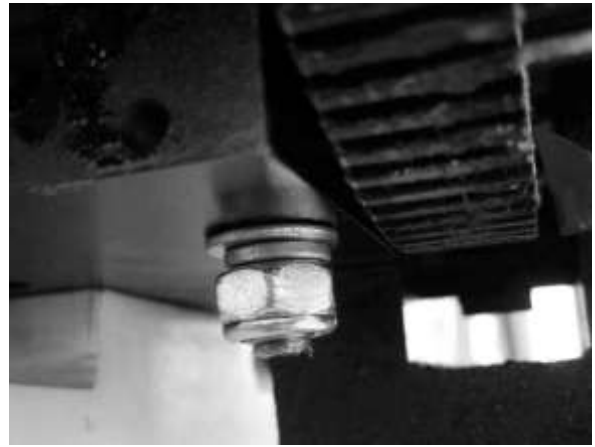
**Note.** If you move the machine, you may find that the leveling bolts will need to be readjusted.

### **Installing the table.**

**Note.** It is recommended that two people be used to mount the table.



**Trunion clamp handle**



**Trunion clamp nut**



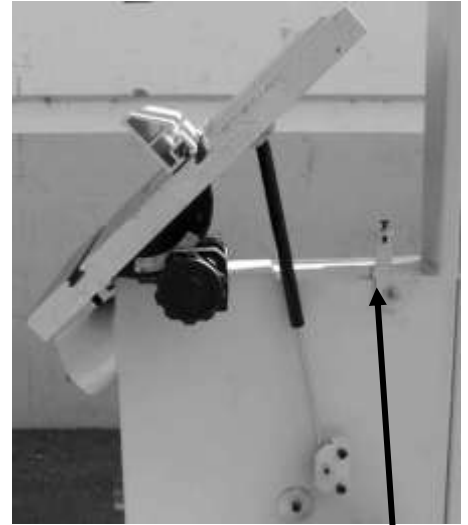
**Gas assistor fitted to body**



**Gas assistor fitted to table**

1. Remove the trunion clamp handle and trunion clamp nut from the relevant bolts.
2. Position the table on the clamp nut trunion, taking care not to damage any of the table or trunion surfaces.

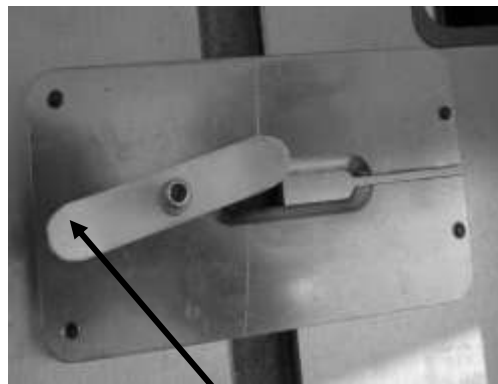
3. While one person supports the table, the other person feeds the bolts through the trunion slots.
4. Fit the trunion handle and the trunion clamp nut. Tighten the trunion clamp nut and handle snugly. You will now fit the gas assistor before you adjust the table clamp nut.
5. The table can be tilted to a maximum of 45 degrees away from the column and 15 degrees toward the column. To assist the movement, a gas assistor is provided. Fit the assistor to the bottom bracket with the spindle provided and fit the spring pin. Compress the assistor and fit the spindle and spring pin to the bracket in the table.
6. The trunion clamp nut can now be adjusted. Tighten the nut so that the table can be moved freely with the rack and pinion handle with the trunion clamp handle loose.
7. To angle the table, loosen the trunion clamp handle. Move the table to the required angle and lock in position. To return the table to the zero position, reverse the procedure.
8. A 90-degree stop is provided that can be adjusted by loosening the clamp nut and moving the bolt up or down. The stop comes factory set, but should movement have taken place during transport, adjust the stop so that the table is 90 degrees to the side of the blade.



**Table stop  
Bandsaw shown with rack & pinion table adjustment**

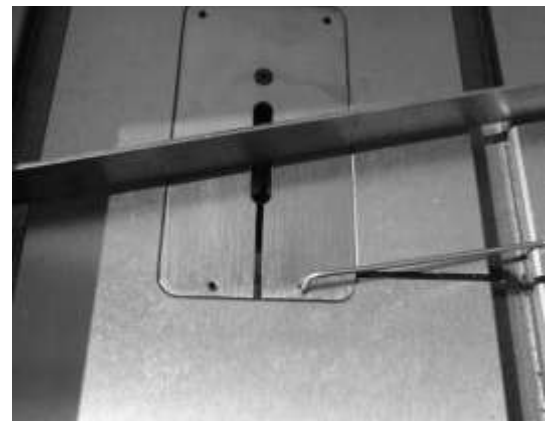
### **Table insert**

The machine is supplied with a removable table insert that is held in position with a wing nut. The table insert is

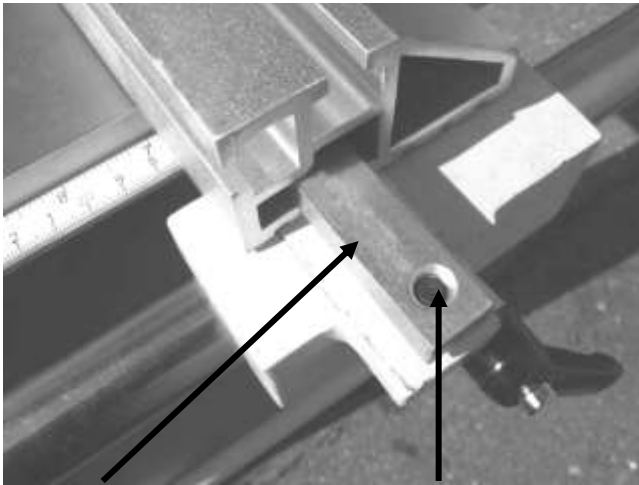


**Table insert wing nut**

removed when blades are removed or fitted to the machine. The insert is made of soft aluminum so that should the blade wander and contact the insert, there is less chance of damaging the blade. Adjusting screws are provided to adjust the insert vertically level with the table. The insert comes factory set but should adjustment become necessary, place the insert in the table with the wing nut in the clamped position. Place a straight edge across the table and insert as shown, adjusting the screws so that the table insert is level with the top of the table.

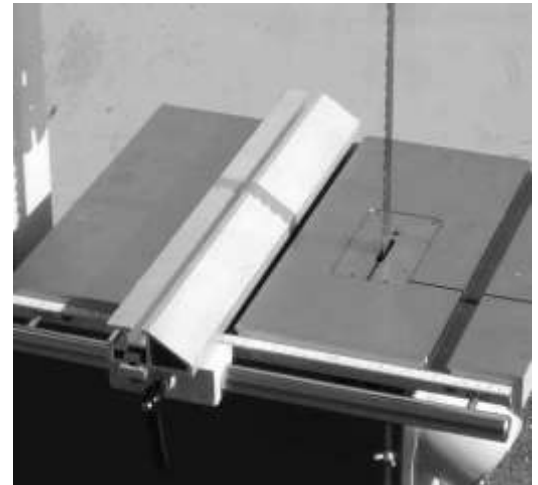


## Fence



Steel block

Fixing screw

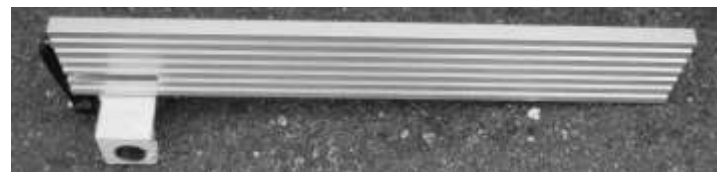


Fence in low position

The bandsaw is supplied with an aluminum fence. Assemble the fence to the cast-iron bracket with the bolts and steel block provided. Adjustment and squaring of the fence will be covered later in the manual. Slide the bracket onto the round steel bar

(attached to the table). The fence is used to the left of the blade, so ensure that it is on the correct side of the table before locking in position with the ratchet handle provided.

**Note:** The fence can be fitted so that it can be used in high or low position (also covered later in the manual).

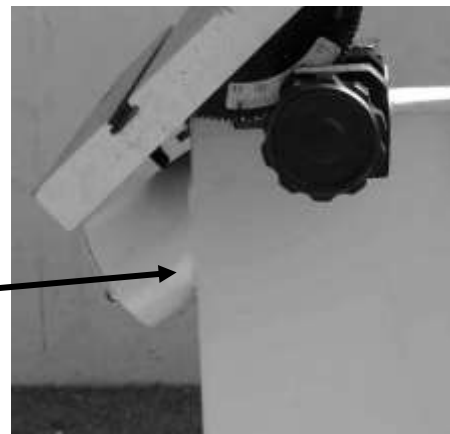


Fence in high position

## Dust collection

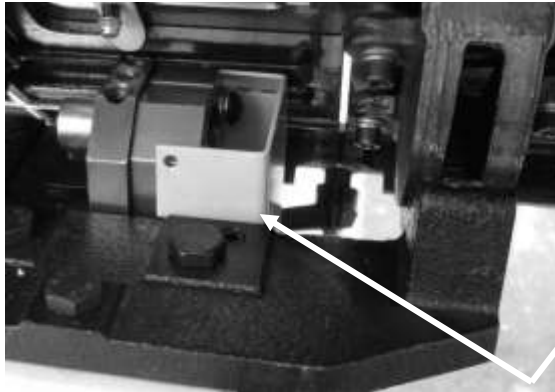


Dust port



The bandsaw must be connected to a dust collection system or machine. As a general rule, the stronger the extraction, the better; but 1,000 cubic feet a minute is the minimum that should be used. The diameter of the dust collection ports on the bandsaw are 4".

### Bottom blade guards



**Bottom blade guard**



It is very important to have the blade covered for safety. Guards are provided at the top of the lower door and just above the table dust port. The door guard must be moved vertically and clamped in position before operating the bandsaw. To open the door, the guard will have to be lowered. Should the blade break, the guards protect the operator from the blade escaping under the table. A third blade guard is provided that must be in position when running the machine. To fit or remove a blade, this guard will have to be removed.



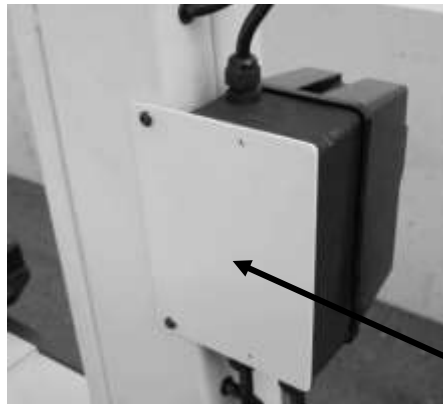
**Blade guard**

### Electrical connection

**Note.** The machine may not be supplied with an electrical plug, as the type of plug will depend on the installation.



**Switch in transport position**



**Switch in operation position**

The switch is mounted on the main pillar of the bandsaw in the incorrect position for operation. This is for transport reasons, and the switch will have to be moved to the operation position prior to starting the machine. Remove the two screws, reposition the switch box and reassemble the screws. Ensure that no strain is exerted on the cable during this procedure. A qualified electrician must carry out the electrical installation. The main connection should be made using the cable supplied and a plug (not supplied) to suit your electrical supply. If you need a longer cable, you can connect a new cable into the switch box, but this must be installed by a qualified electrician.

Ensure that the main supply corresponds with that of the machine, single-phase 220 V. If a longer cable is required, use the below table as a guide for the cable gauge.

**Distance wiring suggested.**

1 phase 0-10 ft 12/3

1 phase 10-15 ft 10/3

1 phase 15+ ft 8/3

All machines require the minimum of a 30-amp circuit breaker.

**Assembling the tool storage bracket**

Install the tool storage bracket to the side of the vertical frame as shown with the two socket head screws and washers.



**Tool storage bracket**

**Before starting the machine**

1. Read and understand the instruction manual before operating the saw.
2. If you are still not thoroughly familiar with the operation of the bandsaw, get advice from a qualified person.
3. Make sure the machine is properly grounded and that the wiring codes are followed.
4. Do not operate the bandsaw while under the influence of drugs, alcohol and medicine, or if tired.
5. Always wear eye protection, safety glasses or a safety shield, as well as hearing protection.
6. Wear a dust mask; long-term exposure to the fine dust created by the bandsaw is not healthy.
7. Remove your tie, rings, watch and all jewelry. Roll up your sleeves; you do not want anything to get caught in the saw.
8. Make sure that the guards are in place and use them at all times. The guards protect you from coming in contact with the blade.
9. Make sure that the saw blade teeth point downward towards the table.
10. Adjust the upper blade guard so that it is just clearing the material being cut.
11. Make sure that the blade has been properly tensioned and tracked.
12. Stop the machine before removing the scrap piece from the table.
13. Always keep your hands and fingers away from the blade.
14. Make sure that you use the proper size and type of blade.
15. Hold the work piece firmly against the table. Do not attempt to saw stock that does not have a flat surface facing down, unless a suitable support is used.

16. Use a push stick at the end of a cut. This is the most dangerous time because the cut is complete and the blade is exposed. Push sticks are commercially available.
17. Hold the wood firmly and feed it into the blade at a moderate speed.
18. Turn off the machine if you have to back the material out of an uncompleted or jammed cut.

### **Machine test**

#### **Now is the time to test the machine.**

1. Close the doors.
2. Check that the red safety switch is in the fully out position.
3. Check that the machine is clear of all tools and other loose objects.
4. Check that all the adjusting and locking handles are tight.
5. Check that there is no blade fitted; it is far safer to test the machine without a blade fitted.
6. Start the bandsaw by pressing the green start button. Once started, release the switch.
7. The lower flywheel is now turning.
8. Now is the time to check that the safety switch is functioning correctly before you fit a blade.
9. With the machine running (no blade fitted), operate the red stop switch by pressing towards the machine. The motor should have the power removed and slowed down.
10. If the safety switch fail to operate correctly, do not use the machine until the fault has been corrected.

### **Adjusting the bandsaw**

#### **Fitting a blade to the bandsaw**

A lot of people do not like to change the blades and go to great lengths to avoid doing it. To use the bandsaw to its greatest advantage, you will have to use the appropriate blade and track it quickly. This is a habit that can be easily developed. If you use a step-by-step method of tracking, the procedure should only take a minute or two. Be careful when using blades, especially wide ones.

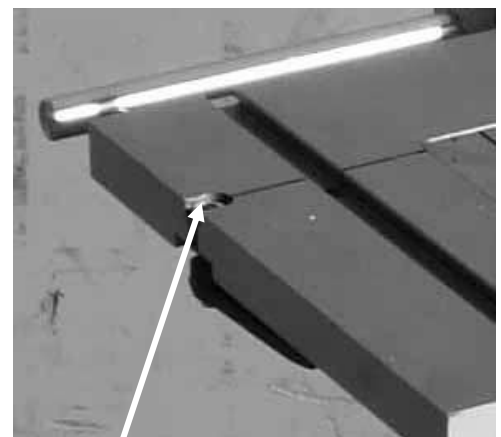
#### **Always use the correct safety equipment.**

#### **Installing the blade**

##### **Disconnect the power to the bandsaw.**

Adjust the side guide and back guide out as far as they will go [both upper and lower guides. This will ensure that they do not interfere with the blade while you are fitting, tracking and tensioning the blade.

1. Uncoil the blade. Remember to use gloves and safety glasses. The blade may have dirt or oil on it, so use a clean rag to clean the blade, pulling rearwards so that the cloth does not hook on the teeth.



**Table split clamp**

2. Inspect the teeth and the general condition of the blade. If the teeth are pointing in the wrong direction when you hold the blade up to the machine, you will have to turn it inside out. To do this, hold the blade with both hands and rotate( see blade section of this manual).

3. Remove the table split clamp. This clamp is used to ensure that the table does not warp and must always be reassembled to the table.

4. Remove the blade guards and raise the blade quick release lever.

5. With the guards removed and the table insert removed, hold the blade with both hands with the teeth towards you. Slide it through the table slot and place it on the wheels. Hang the blade on the top wheel, and then line it up with the lower wheel. If the top wheel needs to be lowered, rotate the tension handle wheel.

6. Apply tension to the blade by lowering the blade quick release lever. Adjust the tension hand wheel. Do not fully tension the blade at this stage.

7. Start rotating the wheels by hand in the normal direction. As you do this, watch the blade to determine where the blade wants to track. If the blade is tracking too far forward or backward, make small adjustments with the tracking adjustment knob located at the back of the bandsaw while still rotating the wheel. Once the blade is tracking in the correct position, fully tension the blade and re-track.

**Note:** The blade must be fully tensioned for final tracking.

**Note:** Never track the blade with the saw running.

8. Lock the tracking adjustment handle.

## **Tensioning the bandsaw blade.**

### **Introduction.**

When people ask how to tension a blade, they usually mean, "How do I make a straight cut and stop a blade from wandering in a cut?" Therefore, we will first cover the main causes for blade wander and then move onto tensioning.

In order to cut straight with your bandsaw, it is important that you have an understanding of how the bandsaw works.

The bandsaw consists of a ridged frame that holds two wheels. The lower wheel is fixed and is driven by a motor. It pulls the blade down and through the wood. The upper wheel is vertically adjustable, usually by a screw. It incorporates a spring that keeps a constant pressure on the blade and also absorbs any shock that the blade experiences.

The ideal situation for a blade is to have the same tension in the area above the job and below the job. This is difficult, as the action of cutting adds a variable into the equation. The bandsaw blade, by its very nature, suffers from a contradiction. It must be flexible to bend around the bandsaw wheels but also stiff enough to resist bending and flexing

**Blade tracking  
adjustment handle**



**Blade quick release  
lever**

**Blade tension hand  
wheel**



between the wheels. The bandsaw achieves this by tensioning the blade and thus stretching it. The next complication is that the blade heats up while cutting the wood and expands its length. This allows the blade to become slacker and lose its tension. To overcome this, the bandsaw has a compression spring that allows for the expansion and keeps a constant pressure on the blade. The spring will compensate for the expansion in all but the most severe cases, such as cutting very hard, thick woods for long periods of time.

Before we tackle blade tensioning, it is worth noting a few causes of blade wander. You might have the blade perfectly tensioned, but the blade still wanders and you could spend a lot of frustrating time adjusting the tension when the cause of the poor cut is not the tension.

### **Causes of blade wander.**

#### **Blades.**

The blade can be the cause of blade wander. If there is more pressure on one side of the blade than the other side, the blade will follow the path of least resistance and move over toward the side with less pressure. Typical reasons for the pressure being uneven are:

##### **1. Dull blade.**

This will cause the pressure to build up on the front of the blade and cause it to move back. This will have a tendency to slightly buckle the blade. This buckling reduces the pressure on the front of the blade and makes it relatively slack, causing the blade to wander.

##### **2. Poor wheel alignment.**

This will cause the blade to be fed through the job with a slight twist and cause the pressures to be uneven. This is not common, as most bandsaws come accurately set from the factory, and unless they have been dropped or mistreated, it should not be a cause for concern. Up-market bandsaws have adjustment for wheel alignment, but this should not be adjusted unless the bandsaw has been accurately checked.

##### **3. Poorly set guides or thrust bearings.**

The guides are there to provide support to the blade, and if they are set so that they are pushing the blade off its natural path, the blade may wander off track. With the thrust bearing set either too far forward or too far back, the blade will bend either back or forward and change the pressure on the cutting teeth of the blade.

If the guides are set too tight, heat is built up in the blade, and this will cause the tension to change. It is also not good for the motor or the blade.

##### **4. Tooth pitch too fine.**

If the pitch is too fine, the gullets of the teeth fill with sawdust and stop the blade from cutting efficiently. This will cause excessive heat buildup and dull the blade quickly. The blocked gullets also affect the cutting action, and this, in turn, changes the cutting pressures and results in blade wander.

##### **5. Wrong blade selection.**

This is one of the more common causes of blade wander. As an example, if a 1/4" blade with 14 TPI is used to cut a 8" block of hard maple, the pressure on the blade will be great, and the feed rate will have to be very slow to have any chance of cutting. The blade will have insufficient beam strength and bend back as the wood is pushed against the blade. The bending of the blade will cause the pressures to be uneven, and, therefore, the blade will wander.



### **6. Teeth set insufficient.**

The set of the teeth is there to create a slot for the back of the blade to pass through. Ideally the body of the blade should not touch the side of the job, but this is not practical, and the best that we can hope for is that little pressure is caused on the blade. If the set is insufficient, the blade will heat up as it rubs on the wood, and the cut will be slow, similar to cutting with a dull blade.

### **7. Uneven sharpening of the teeth.**

If the teeth are not ground evenly, the pressure during cutting will be different on the sides of the blade, and the blade will follow the path of least resistance and wander.

### **8. Uneven set.**

If the set of the teeth is not the same, the pressures will be different on the sides of the blade, and the blade will follow the path of least resistance and wander.

### **9. Blade speed insufficient.**

If the blade speed is too slow for the job at hand, the gullets will block with sawdust and cause uneven pressures on the blade. This will cause blade to wander. To correct this, slow the feed rate.

### **10. Blade drift.**

Each blade has a natural cutting angle (drift). This is the angle that it will cut at and it may not be square to the table. If you are using a fence as a guide to cut parallel, it will have to be set to this cutting angle.

### **Adjusting the fence for drift.**

#### **Method 1.**

1. Make a straight pencil line on the edge of a board.
2. Feed the wood into the blade, cutting next to the pencil mark. If the blade is drifting, you will have to compensate by angling the wood and that way keep the cut straight.
3. Stop the cut in the middle of the wood and mark with a pencil the angle on the table. This is the angle of drift, and you will have to set the fence to the pencil line.
4. To adjust the fence, loosen the clamp bolts that attach the aluminum extrusion to the cast iron knuckle. Move the aluminum extrusion so that it lines up with the pencil mark on the table and re-tighten the clamp screws.

#### **Method 2 (Recommended).**

1. Set the fence parallel with the blade by loosening the clamp screws that hold the aluminum extrusion to the cast iron knuckle. It is not important that it is exact, as you will be readjusting later in the procedure.
2. Using a piece of scrap wood, make a cut while holding the wood against the fence. Stop the cut in the middle of the wood and stop the bandsaw.
3. Look at the position of the back of the blade within the saw cut. The back of the blade should be in the center of the slot, but you will probably find that it is closer to one side.



**Blade not centered in saw cut**



**Blade centered in saw cut**

4. Slightly loosen the clamp screws and adjust the fence to compensate.

5. Repeat steps 2, 3 & 4 until the blade is centered.

**Note.** You may have to do several fine adjustments, and it is better to do several small adjustments until you become skilled at the procedure. Once you have mastered the process, it should only take a minute to perform the adjustment.

**Note.** Each blade has a slightly different drift, and each time you change a blade, you must check and readjust if necessary.

**Note.** It is worth taking the time to set the fence accurately, as it will save frustration, enhance the performance of your machine, reduce stress on the blade and improve the surface finish of the cut.

**Note.** Always turn off the bandsaw when making adjustments to the fence.

There are other factors that will cause the blade to wander, and it seems very daunting when you first start to cut with the bandsaw. Do not give up, as once you have mastered the bandsaw, you will find that it is one of the most versatile machines in the shop.

### **Tensioning.**

There are a lot of differing points of view on how to tension a blade and if you should buy a blade tension gauge. Before you purchase a blade tension gauge, note the following points: Tension gauges are expensive, and once you gain experience, you will, in all probability, not use it again.

Most blade tension gauges are fitted to the blade and measure the amount the blade stretches when you tension it. Each blade manufacturer uses a different type of steel with different tensile strength. This means that each type of steel has a different rate of stretch. For example, if you buy a tension gauge from one blade manufacturer, it is designed for use on its blades, or only a range of blades, and will not necessarily give you accurate readings in lbs/square inch on another manufacturer's blades because their blades stretch at a different rate. In reality, there is nothing quite as quick or as accurate as experience. If your machine is fitted with a blade tension indicator, it will probably measure the deflection of the tension spring on the upper flywheel. We recommend that you use it only as a general guide. Once the correct tension for a specific blade has been found, note the position of the tension indicator so that it will give you a good starting point for refitting the blade.

Use one of the following tensioning procedures to tension the Resaw King or other blades.

The blade tension indicator, mounted on the inside of the bandsaw in the top right-hand corner, is used as a general guide.

### **Method 1.**

Looking at the top wheel, place your finger at the 9 o'clock position. Move your finger down 6", and using moderate pressure with your thumb, press on the flat of the blade. You should get 3/16" to 1/4" of deflection.



**Blade tension indicator**

Refit all the guards and close the doors. Replace the table insert and check that the blade moves freely through the table insert. Check that all wrenches and loose parts are removed from the machine.

Plug the machine into the power. Turn the machine on for a second and switch off. Watch how the blade runs. If the blade tracks well, then run the machine at full power. If the blade tracking needs adjustment, repeat adjustment.

### **Method 2.**

Tension the blade as described in method 1.

Close all the doors and ensure that all the guards are fitted.

Start the bandsaw and look at the blade from the front of the machine. Start to distension the blade very slowly until the blade starts to flutter (wobble from side to side). Then start to tension the blade until the blade stops fluttering and is running true. Increase the tension on the blade by one complete turn on the tension handle. You may find that each size and type of blade will need more or less additional tension. For example, a 1/16" blade will need less additional tension than a 1 1/2" blade. Again, experience is the key, and with a little practice, it will become second nature.

The key to all tensioning is to get the blade to cut straight and true with the minimum amount of tension. The less tension you put on the blade, the longer the blade and the machine will last.

**Note.** The upper flywheel has a spring that is used to keep a constant pressure on the blade during use. As the blade cuts, heat is generated, which causes the blade length to expand. The spring compensates for the change in length, and you must never bottom out the spring while tensioning the blade.

**Note.** If you are not using the bandsaw for extended periods of time (overnight), remove the tension on the blade. This will increase the life of your blade and the machine. If tension is left on the machine, flats or grooves can be formed in the rubber of the wheels, which will detract from the performance of the machine and in extreme cases cause vibration.

Removing the tension will greatly enhance the life of the machine, bearings and tires.

Label the machine "de-tensioned." On the label mark the number of turns that you de-tensioned; this way you will know how many turns that you have to put back on to have your blade correctly tensioned.

### **Removing the blade from the bandsaw**

1. Disconnect the power to the bandsaw.
2. Remove the table split clamp that aligns the two table halves.
3. Remove all the guards.
4. Remove the table insert.
5. Remove the tension on the upper flywheel.
6. Open the doors and remove the blade from the wheels (use gloves and eye protection) and gently slide the blade through the table slot.

## **Tracking position of the blade on the wheels**

### **Tracking large blades.**

There has been a lot of discussion on the position that the blade should be on the wheels. One group of people recommends that with large blades you should track the blade so that the teeth hang just over the front edge of the rubber. The second group recommends that all blades, regardless of their size, should run in the center of the wheel. The advantage of running the large blades with the teeth not contacting the rubber of the wheel is that they cannot damage the tire. The disadvantage is that the wheel is crowned and the blade is not tensioned in the center of the band, which gives the blade a tendency to wobble or flutter. The advantage of running large blades on the center of the wheels is that they are tensioned in the center of the band and have fewer tendencies to wobble and flutter. The disadvantage is that blades with a large set on the teeth have a tendency to damage the rubber of the tire. This does not have a great effect on the performance of the bandsaw, as all blades are running on the center section of the tire, which is not affected. We recommend that you balance all blades on the center of the wheels for optimum performance and a smoother cut.

## **Adjusting the blade guides**

### **Introduction**

Welcome to a new era in bandsawing. You have purchased a bandsaw with a revolutionary blade guide system that is designed to give you years of safe, high-quality bandsawing. Most blade guides are designed to support the blade on the sides and either above or below the side guides the back of the blade. This can allow the blade to twist as pressure from the wood being cut pushes against the back blade guide. The Laguna Guide eliminates this by supporting the blade above and below the back blade guide, giving the blade unsurpassed stability. The Laguna Guide also incorporates patented ceramic as the blade support material. The advantage of this material is its ability to resist wear, and with care, it should give years of safe service.



**Upper guide**

**Please read the following notes, as they will assist you in getting the optimum performance from your Laguna Guide system.**

1. As with the roller guide systems, the Laguna Guide system will damage your blade if it is not adjusted correctly. The guide blocks must not come in contact with the teeth of the blade. It is advisable to run the blade by hand with the guide blocks completely clear of the blade, and only when you are completely sure that the blade is running consistently in the correct position, then adjust the surround guide blocks as detailed in this manual.
2. When fitting a new blade to your bandsaw, adjust the guide blocks and run the blade by hand through the guide blocks for at least two complete revolutions.

**Note:** The weld on a new blade may not be perfectly aligned, and the misalignment could hit the ceramic blocks (side and back), causing damage to the blocks and or the blade. If the blade has a bad weld, return it to your blade supplier or side dress and file the back of the blade as needed.

3. The back blade guide is manufactured from ceramic, so as the blade pushes against it, friction between the blade and the ceramic occurs. This action generates a certain amount of sparks. This is normal and will reduce with time as the back of the blade guide smooths out the back of the blade.

4. The back blade guide will slowly form a small groove as the blade is used (this is normal). It is recommended that for approximately every 8 hours of use, the guide be rotated 15 degrees. This will ensure that the groove does not become too deep and will greatly extend the life of your guide.

5. The Laguna guide system can be used with 1/4" to 1 1/4" blades.

6. The Laguna guide system uses ceramic to support and guide the blade. This has many advantages, (very poor conductor of heat, very resistant to wear, etc.). The disadvantage is that it is very brittle, so the guides must never be dropped, exposed to hard knocks, hit with hard objects or used with badly welded blades. Any of the above actions may cause the ceramic to chip or break and will detract from the performance of the Laguna guide system. Any mistreatment of the guide system will render the warranty void.

7. The side guide blocks must be tightened before running the machine to avoid jamming the blade and damaging the machine and/or guide blocks.

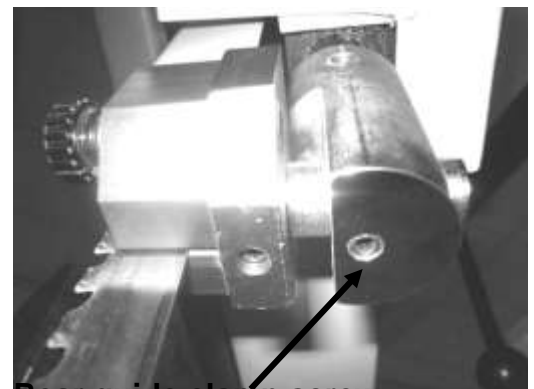
8. When cutting gummy or green wood, the blade can become covered with resin. You will find that the surround guide system ceramic blocks remove the resin as the blade is moved through the guide blocks and keep that part of the blade clean. For this reason it is recommended that the blocks be adjusted as close to the gullet as possible, but the teeth must not come in contact with the blocks, as they will become damaged. Although the guide blocks clean the blade, some woods will gum the blade, and the resin will have to be removed with solvent. Do not lubricate the ceramic guide blocks.

### **Adjusting the blade guides**

The blade should run through the center of the rear blade guide, and the side guides should be parallel with the blade. If they have been moved out of adjustment, adjust as follows:

#### **Upper side guides parallel adjustment.**

Loosen the clamp screw that attaches the guide to the vertical shaft and rotate the assembly until the side guide is parallel to the blade. Retighten the clamp screw. There is no adjustment on the lower guides. We are now ready to adjust the guides to the blade.



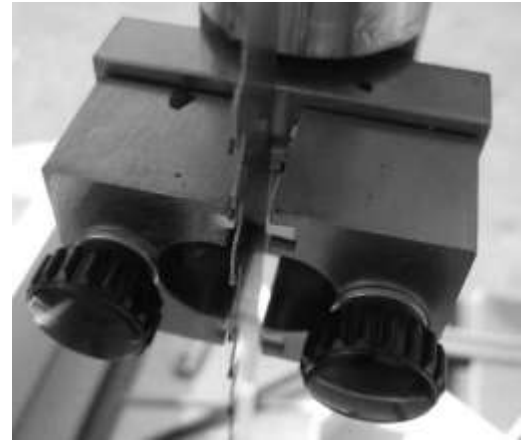
**Rear guide clamp screw**

### **Top guide**

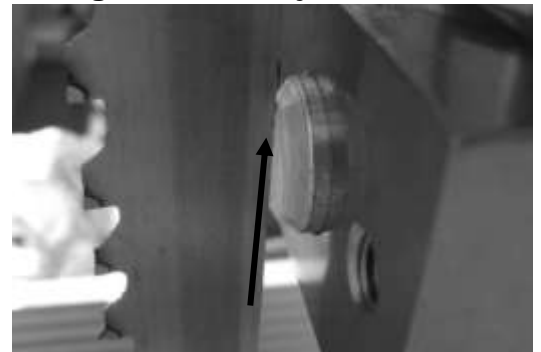
1. Loosen the side guides.
2. Rotate the blade by hand and ensure that it is tracking consistently in the correct position.
5. Loosen the rear guide clamp screw and push the guide forward so that it just touches the back of the blade. Tighten the guide in position.
3. Loosen the guide clamp screws that allow the back guide to move forward and back. Adjust so that the ceramic blocks are just behind the gullet of the tooth and retighten the clamp screws.
4. Gently push one side guide so that it touches the blade and lock in position. Bring the other guide toward the blade so that there is minimal clearance between the blade and the guide. You can use a thin piece of paper to put between the blade and the guide to obtain the correct clearance until you gain experience. Tighten the clamp screws and remove the paper. Rotate the blade by hand, ensuring that the weld of the blade does not hit the ceramic blocks, as this will cause damage. If the blade has a bad weld, dress the blade or return it to your supplier.
6. Rotate the blade by hand and check that the back of the blade does not hit the blade guide with a bad weld. If the back of the blade hits the back blade guide at the weld, then dress the blade or, in excessive cases, return the blade to the supplier.

### **Lower blade guide**

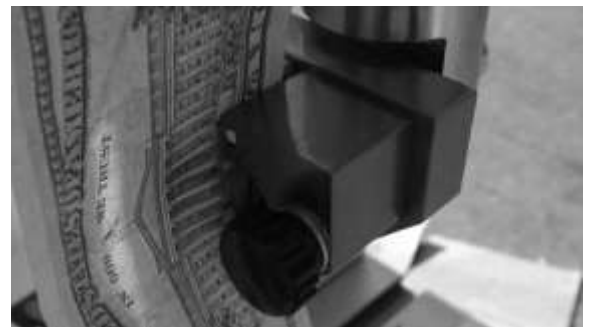
1. Rotate the blade by hand and ensure that is tracking consistently in the correct position.
2. Loosen the side guides.
3. Loosen the two clamp screws that allow the guide assembly to move forward and back. Adjust so that the ceramic blocks are just behind the gullet of the blade and retighten the clamp screws.
4. Place a dollar bill or piece of paper of similar thickness between the guide blocks and the blade. Gently bring both side guides toward the blade so that slight pressure is exerted on the blade. Tighten the clamp screws and remove the paper. Rotate the blade by hand, ensuring that the weld of the blade does not hit the ceramic blocks,



**Side guides not adjusted**



**Rear blade guide shown with the side guides removed**



**Forward & back clamp screws**

as this will cause damage. If the blade has a bad weld, dress the blade or return it to your supplier.

**5.** Loosen the rear guide clamp screw and push the guide forward so that it just touches the back of the blade. Tighten the guide in position.

**6.** Rotate the blade by hand and check that the back of the blade does not hit the blade guide with a bad weld. If the back of the blade hits the rear blade guide at the weld, then dress the blade or, in excessive cases, return the blade to the supplier.

**Note:** Rotate the back guide by approximately 15 degrees after every 8 hours of use. This will greatly extend the life of the back blade guide, as it will even out the wear.

**Before you cut any wood, read the safety rules at the front of this manual.**

### **Using the bandsaw**

Although the bandsaw is usually associated with cutting curves, a variety of straight cuts are easily made with the saw. In fact, it is often used to rip wood because it is much safer than a radial arm saw and also has a smaller saw cut, so wastes less wood. This becomes very important when using expensive wood where wastage must be kept to a minimum. The cut is safer because the force of the cut is straight down on the table, so the work cannot be pulled back or kicked back, which sometimes happens with table or radial arm saws.

The bandsaw can also cut very thick stock, which the radial arm or table saw cannot do. The disadvantage of cutting with the bandsaw is that the surface finish of the cut is not as good as with the table or radial arm saw. This can be overcome to a great degree by using the Resaw King blade from Laguna Tools. The blade has a lot of advantages such as superior surface finish to the cut, thin kerf (low wood wastage), ability to be re-sharpened, will cut hard woods and a long life.

### **Ripping**

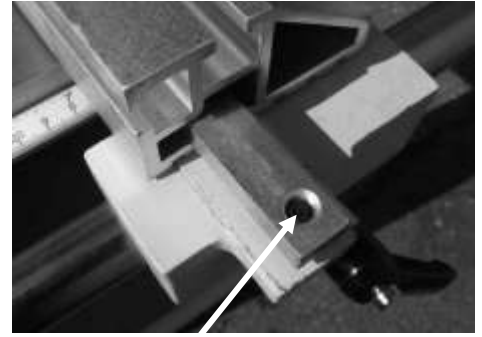
Ripping is a cut made with the grain of the wood. The four most common cuts made with the grain of the wood are rip, bevel, taper and resaw cuts. There are two frequently used techniques for making straight bandsaw cuts. One technique is to use a single point to guide the work. The rationale for using a single point is that the saw may tend to cut at a slight angle. This is called drift or lead. The single point allows the operator to compensate for the drift and cut the wood straight. With a little practice, you will obtain satisfactory results using this method. However, you own a real bandsaw, so this method is not recommended. Another method is to use the rip fence as a guide. Once set up, this takes the guesswork out of cutting, reduces the stress on the operator and is a must for volume work. Once you have mastered the setup procedure, you will tend to use the single-point method less and less.

### **Fence positions**

The aluminum fence can be used in two height positions (high and low). The low position is handy for cutting thin wood and is used where the fence in the high position would make it awkward to complete cuts. The fence in the high position is used for supporting tall work.

## Changing the fence height

1. Loosen the two clamp screws that are located on the cast-iron bracket.
2. Slide the aluminum fence off the cast iron bracket.
3. Slide the aluminum fence back onto the bracket using the second slot and retighten the clamp screws.



**Clamp screws**

Resawing is the process of cutting a board in half along its height. The bandsaw is perhaps the most creative tool in the shop because of its ability to cut thick or thin, straight or curved. The ability to cut thick stock such as resawing, making veneers, book matching or cutting flitches from small logs has great appeal to the woodworker. These capabilities greatly enhance the woodworker's design ability without the need for additional equipment. When a board is resawed and the two pieces are lying next to each other, you will note that they are mirror images of each other. When these two boards are glued together, it is called book-matching.

**Note: It is unsafe to cut wood that is unsupported by the table and should never be attempted. This is especially important to note when cutting round logs.**

## Blades

### Introduction

The selection and use of blades is a very extensive subject, and there have been many books written on the subject. This section of the manual is intended as a general guide only.

### Selecting a blade

Using the correct blade is important, as it is the first step in attaining good bandsaw performance. The most frequently asked question is "How do I decide on the correct blade to use?" The answer is not simple, and we will explore it in this section of the manual. Firstly, there is **NO** ideal blade that will do everything. The blades that you choose will be determined by the type of work that you are doing. Large-tooth wide blades are selected for fast, coarse cuts, and fine thin blades are used for intricate scrollwork. You will find that you will need a large selection of blades if you do a lot of varied work and fewer blades if you are concentrating on one section of bandsawing such as resawing. Using the wrong blade is the best way to abuse it. Using a blade for its intended purpose allows for maximum efficiency and is the best way to prolong its life.

### Blade terms

#### Set

The amount that the teeth is wider than the thickness of the backing material is the set. The larger the set, the larger the saw cut, and the smaller the radius that can be cut. This can also be an advantage if you are cutting a job that has a tendency to nip the blade. The



smaller the set, the smaller the saw cut, and the larger the radius that can be cut, but the wood is wasted less. On tipped blades (Resaw King), there is no set, as the tip is wider than the backing material.

### **Thickness**

The thicker the blade, the stiffer the blade, and the straighter the cut. The thicker the band, the greater the tendency for the blade to break.

### **Pitch**

The size of the teeth. This is usually quoted in teeth per inch (T.P.I.). The larger the tooth, the faster the cut because the tooth has a large gullet and has a greater capacity to transport large amounts of sawdust through the job. The larger the tooth, the coarser the cut and the poorer the surface finish of the cut. The smaller the tooth, the slower the cut, as the tooth has a small gullet and cannot transport large amounts of sawdust through the job. The smaller the tooth, the finer the cut and the better the surface finish of the cut

### **Material Hardness**

When choosing the blade with the proper pitch, one factor you should consider is the hardness of the material that is being cut: the harder the material, the finer the pitch that is required. For example, exotic hardwoods such as ebony and rosewood require blades with a finer pitch than American hardwoods such as oak or maple. Soft wood such as pine will quickly clog the blade, decreasing its ability to cut. Having a variety of tooth configurations in the same width will most likely give you an acceptable choice for a particular job. There are certain things that indicate if a blade has a proper pitch, too fine a pitch or too coarse a pitch. Some are listed below.

### **Proper Pitch**

Blades cut quickly.

A minimum amount of heat is created when the blade cuts.

Minimum feeding pressure is required.

Minimum horsepower is required.

The blade makes quality cuts for a long period.

### **Pitch is Too Fine**

The blade cuts slowly.

There is excessive heat, which causes premature breakage or rapid dulling.

Unnecessarily high feeding pressure is required.

Unnecessarily high horsepower is required.

The blade wears excessively.

### **Pitch that is Too Coarse**

The blade has a short cutting life.  
The teeth wear excessively.  
The bandsaw vibrates.

### **Width**

The dimension from the back of the blade, to the front of the teeth. The wider the blade, the stiffer the blade and the straighter the cut. This is usually called beam strength. But wide blades cannot cut small radiuses. The narrower the blade, the more flexible the blade and the greater the tendency the blade has to wander. They have low-beam strength but can cut small radiuses. Blades are available from 1/16" for your machine, but for very narrow blades, the normal guides have to be replaced with cool blocks (not supplied with the machine).

### **Kerf**

The width of the saw cut. The larger the kerf, the smaller the radius that can be cut. But the greater the amount of wood the blade has to be removed by the blade, and the greater the horsepower that is needed, as the blade is doing more work. The greater the kerf, the larger the amount of wood that is being wasted by the cut.

### **Hook or rake**

The cutting angle, or shape of the tooth. The greater the angle, the more aggressive the tooth and the faster the cut. But the faster the cut, the faster the tooth will blunt and the poorer the surface finish the cut will have. Aggressive blades are suitable for soft woods but will not last when cutting hard woods. The smaller the angle, the less aggressive the tooth, the slower the cut, and the harder the wood that the blade is suitable to cut. Hook teeth have a progressive cutting angle and take the form of a progressive radius. They are used for fast cutting where finish is not important. Rake teeth have a flat cutting angle and are used for fine surface finish of the cut.

### **Gullet**

The area for the sawdust to be transported through the wood in. The larger the tooth (pitch), the bigger the gullet.

### **Relief**

The angle from the tip of the tooth back. The greater the angle, the more aggressive the tooth but the weaker the tooth.

## **Beam strength**

This is the ability of the blade to resist bending backwards. The wider the blade, the stronger the beam strength; therefore, a 1" blade has far greater beam strength than a 1/8" blade, will cut straighter and is more suitable for resawing.

## **Blade selection**

As you will have seen from the previous section, there are a great number of variables. The blade selection that you make will greatly depend on the type of work that you are doing or intend to do with your machine. If you have experience with the bandsaw, you will probably have a good idea of the blades that are suitable for you. If you lack the experience or are unsure of the type of work you will be doing with your machine, we recommend that you purchase a selection similar to that listed below, which is a good general selection and will tackle most jobs. As you gain experience, you will settle on the blades that suit you.

1. 1/4" 6 T.P.I. This is a small, aggressive blade that is suitable for tight curves and fast cutting where good surface finish of the cut is not important.
2. 1/4" 14 T.P.I. This is a small, fine blade suitable for reasonably tight cuts where the surface finish is important but speed of cut is less important.
3. 1/2" 3 T.P.I. This is a general-purpose blade that can cut large radiuses and short sections of straight cuts. The cut is fast, and the surface finish of the cut is poor.
4. 3/4" 3 T.P.I. This is a general-purpose blade, which will be used for straight cuts and is suitable for large radiuses.
5. 1" 2 T.P.I. This is a resaw blade, which will be used for straight cuts and is suitable for processing veneers.
6. If you are going to be cutting hard woods or require superb surface finish, then you should consider purchasing a Resaw King blade from Laguna.

## **Receiving your Resaw King blade.**

Every effort has been made to ensure that your blade arrives in perfect condition. When you receive your blade open the packaging and inspect the blade for damage. If the blade is damaged do not use it but contact Laguna Tools within 24 hours.

**Using a damaged blade is dangerous.**

## **Unpacking your Resaw King Blade**

When opening the blade wear gloves and other protective equipment as the blade is under tension and when released could spring and cause injury.

If you send the blade back for sharpening, or for any other reason, package the blade in a similar fashion to the method received. We cannot accept responsibility for shipping damage, or damage caused due to poor packaging.

It is likely that your blade will be supplied coiled. Uncoil the blade as follows.

2. Untwist the blade insuring that the teeth do not catch on clothing or cause injury.

1. Lightly place your foot on the bottom of the blade [one coil only]. It is recommended that the blade is placed on material that will not damage the blade teeth [wood or cardboard]. Your foot is there to give stability, and not to clamp the blade, so do not exert excessive force, or the teeth band may be damaged.



**Coiled blade**



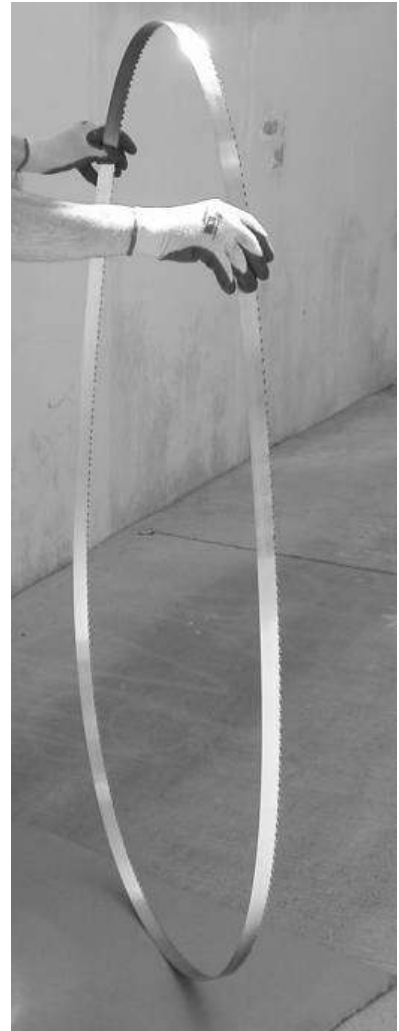
**Foot holding blade**



**Uncoiling blade**



## Teeth direction.



**Blade uncoiled**

If the teeth are not facing the correct direction [facing up when fitted to the bandsaw], Rotate the blade as below.

1. Lightly place your foot on the bottom of the blade. It is recommended that the blade is placed on material that will not damage the blade teeth [wood or cardboard]. Your foot is there to give stability, and not to clamp the blade, so do not exert excessive force, or the teeth / band may be damaged.
  2. Place your hands as shown, with your thumbs facing out.
  3. Twist your wrists so that your thumbs are facing each other. The top part of the blade is now twisted in the teeth facing in the opposite direction.
- Note.** You may have to over twist the blade to get the top of the blade to flick over.
4. Remove your foot slowly and shake the blade until the blade band is not twisted.
- Note.** Safety gloves and goggles must be worn when handling the blade as the teeth are sharp and could cause injury.

## Coiling the blade.



**Hand position**



**Blade coiling**



**Blade coiling**



**Blade coiling**



**Blade coiled**

If you need to coil the blade, coil as follows.

1. Lightly place your foot on the bottom of the blade. It is recommended that the blade is placed on material that will not damage the blade teeth [wood or cardboard]. Your foot is there to give stability, and not to clamp the blade, so do not exert excessive force, or the teeth / band may be damaged.
2. Place your hands as shown, with your thumbs facing out.
3. Twist your wrists so that your thumbs are facing each other. The top part of the blade is now twisted in the teeth facing in the opposite direction.

**Note.** You may have to over twist the blade to get the top of the blade to flick over.

4. Fold the blade down until three coils are generated.

Remove your foot and shake the blade until three even diameter coils are achieved.

**Note.** Safety gloves and goggles must be worn when handling the blade as the teeth are sharp and could cause injury.

## **Rounding the back of the blade**

With most guide systems, it is recommended that the back of the blade be rounded with a stone. As the machine is supplied with Laguna ceramic guides, this is not imperative, as the ceramic will round the back of the blade as it is used. However, if you decide that you want to round the back of the blade, below is a procedure. A round blade back creates smooth interaction between the thrust bearing and the blade. If the blade rotates slightly, there is no sharp blade corner to dig into the thrust bearing; also, the rounding process smoothes the weld. A blade with a round back makes tight turns better because the round back has smooth interaction with saw kerfs. After the guides have been adjusted and the machine is running, hold the stone against the back corner of the blade for about a minute. Wear safety glasses when rounding the blade. Then, do the same thing on the opposite corner. Next, slowly move the stone to round the back. The more pressure you put on the back, the faster you will remove the metal. Be careful that the inside of the machine is free of sawdust because sparks could start a fire. On small blades such as a 1/8" blade, the pressure on the back of the blade may bring the blade forward off the front of the wheels. Therefore, be careful not to put too much pressure on the stone. When doing this, it is also important that the upper guides are positioned right above the stone.

**The blade has teeth, and extreme caution must be exercised, as your hands will be very close to them.**

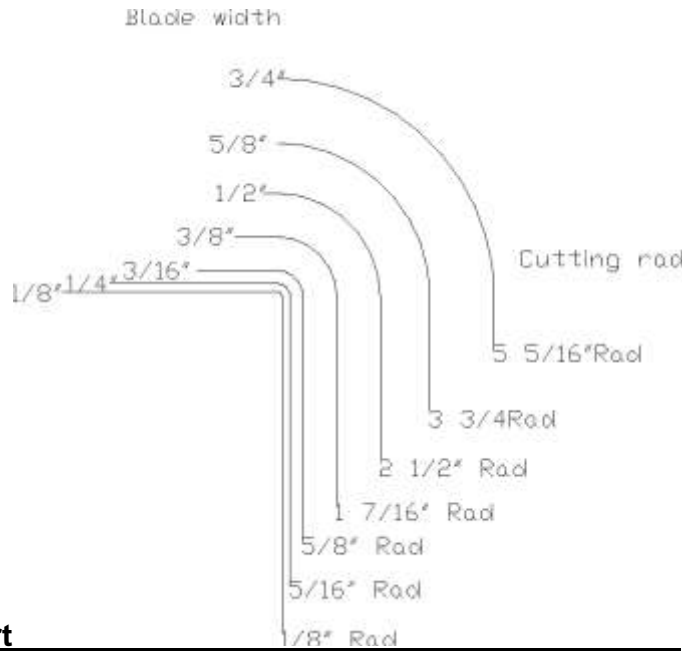
## **Causes of Blade Breakage**

1. Excessive blade thickness in relation to the flywheel diameter.
2. Defective welding.
3. Incorrect tension, particularly if the blade is over tensioned, the tension spring no longer fulfils its function.
4. After use it is recommended to slacken the tension, especially overnight (placing a visible notice of this operation).
5. Misalignment of the flywheels.
6. Irregularity of flywheel surface, e.g., an accumulation of sawdust while cutting resinous materials.
7. You can correct these problems by readjusting the machining, changing the way you operate it, or by changing the blade. Try only one change at a time.

## **Causes of the blade dulling**

1. Poorly set side guides and/or rear thrust guide.
2. Poor tracking.
3. Wrong blade selection. If the blade is too narrow, it will flex more easily and decrease the quality of the cut. The blade should also have the correct pitch and width.
4. The tooth pitch is too fine (too many teeth per inch).
5. Certain woods will dull a steel blade very quickly, especially tropical hardwoods (teak, koa, etc.). Other woods with a high silicon content will also dull the blade quickly; even a cut as short as 6" will cause damage to the blade.

6. On certain exotic woods, the ends have been painted. This is done to control the drying. The paint is very abrasive and will dull the blade if you cut through it. It is recommended that you cut the painted ends off your wood.



### Using a radius chart

Until you become well acquainted with your saw, it is best to use the contour (radius) chart to determine which size blade to use for a specific application. Radius charts can be found in many woodworking books, magazine articles, and on blade boxes. They differ slightly from one another but are good as rough indicators of how tightly a curve can be cut with a particular blade. Each saw blade and operator is different, so it is impossible to make a truly accurate chart. A blade can cut continuously without backtracking any curve that has a radius as much as or more than is shown on the chart. For example: a 3/16" blade will cut a circle with a 5/16" radius or a 5/8" diameter. To test if a 3/16" blade would work for a particular curve, place a dime (roughly 5/8") over the pattern. The 3/16" blade can cut a curve bigger than the dime, but not smaller. You can use everyday items such as coins or a pencil to determine which blade to use. A quarter is the size of the tightest cut that can be made with a 1/4" blade. A dime is the size of the tightest curve that can be cut with a 3/16" blade. A pencil eraser is the size of the tightest turn that you can make with a 1/8" blade. After a while, you won't even need an object to size the possible curve of a blade because you will have become familiar with this process. There are options to matching the blade to the smallest curve pattern. If there is only one very tight cut, it may be best to use a turning hole, a relief cut, successive passes, or to change the blade. If you have a lot of cutting to do, you can use a wider blade for the bigger curves and then switch to a narrower blade for the tighter curves. Changing the blades can often save cutting and finish time. The chart above is only a rough guide and is **not to scale**, but from the information you can construct your own guide.



## **Maintenance and troubleshooting**

All tools and machines require regular maintenance, and the bandsaw is no exception. This section details the general maintenance and care of your bandsaw. In general, we recommend that you only use a Teflon-based lubricant on the bandsaw. Regular oil attracts dust and dirt, and the Teflon tends to dry and has fewer tendencies to accumulate dirt and sawdust on your machine.

### **Cleanliness and tire maintenance**

One of the major concerns is the cleanliness, in particular, how clean the tires are. As the saw cuts, some sawdust lands on the tire of the lower wheel. As the wheel rotates, the sawdust becomes compressed on the tire. This is especially true for woods such as pine. The compressed sawdust could have a negative effect, such as vibration, short blade life and drifting of the blade. A brush contacts the lower wheel and helps to prevent buildup. You should inspect the tires regularly to check that buildup is not happening, especially the lower wheel. The tires are made of rubber and wear just like car tires. They wear in the middle, which causes a concavity in the tire. The deformation makes it hard to track the blades, and for this reason, it is important to maintain the original shape of the tire. The best way to clean the tire surface and maintain the original shape is to sand it with sandpaper. The old tire surface often hardens and glazes over and should be redressed occasionally. This can be done by sanding the wheel with 100-grit sandpaper. This will take off a little of the rubber and expose new rubber, which is desirable. Rotate the wheels by hand with the blade removed.



### **Guides**

The ceramic side and back guides should be inspected regularly for cracks and chips. If they are damaged, they should be replaced, as they could damage your blades, and bad guides will detract from the performance of the bandsaw. The guides should be cleaned regularly and any wood gum or dirt removed. Any commercially available solvent can be used.

### **Drive belt(s)**

The drive belt should last for many years [depending on the usage] but needs to be inspected regularly for cracks, cuts and general wear. If damage is found, replace the belt. If your machine is a 2-belt system, then both belts must be replaced at the same time, as they are a matched pair. Never change only one belt, as this could cause vibration.

### **Replacing the drive belt(s)**

To replace the belt(s) you will have to remove the lower wheel.

1. Remove the Allen screw that clamps the wheel to the axle.

2. Using a gear puller, remove the lower wheel. Take care not to damage the clamp screw thread.
3. Replace the drive belts.
4. Refit the lower wheel and re-clamp with the Allen screw. It is better to replace the drive belt(s) early than to have a breakdown during an important job.

### **Table insert**

The table insert (throat plate) is made of aluminum and is designed to reduce damage to the blade should they come in contact. If the blade slot becomes too wide or the insert becomes damaged by the blade, it should be replaced. The replacement insert will have to be fitted to the table hole. The insert is provided with four jacking screws that can be adjusted so that the insert is level with the top of the table.

### **Bearings**

All bearings are sealed for life and do not require any maintenance. If a bearing becomes faulty, replace it.

### **Rust**

The bandsaw is made from steel and cast iron. All non-painted surfaces will rust if not protected. It is recommended that the table and fence bar be protected by coating with wax if the machine is not in constant use. All moving non-painted surfaces (guides, rack and pinion, etc.) should be lubricated/protected with a Teflon-based lubricant.

### **Rack and pinion**

The band saw is fitted with a rack and pinion, which raises and lowers the upper guides. It should run smoothly. If there is excessive play or it is too tight, the following adjustment can be made.

1. Loosen the Allen screws that clamp the vertical adjustment handle to the bandsaw.
2. There is clearance in the holes, and the vertical adjustment handle can be adjusted.

**Note:** The machine comes factory set, and no adjustment should be required.

### **Top guide vertical adjustment shaft**

The top guide, when moved vertically, tracks the blade and comes factory set. Adjustment is provided should that mechanism become misaligned. This is a tricky operation and should only be attempted if an extreme error has occurred.

### **Adjustment procedure**

1. With the guide at its highest position, adjust the side guides so that there is approximately 1/16" clearance on each side.
2. Adjust the back guide so that it is 1/16" behind the back of the blade.

3. Attach a piece of paper to the table with scotch tape/masking tape in the area covered by the blade guide.
4. Lower the guide and mark its position on the paper. This will give you a reference point to work from.
5. Move the guide up and down and note any change in the relationship between the blade and the guide (both side and back).
6. Only if adjustment is needed, loosen the two bolts on the guide plate and move the guide back/forward, left/right, depending on the adjustment needed.
7. Tighten the two bolts on the guide plate and move the guide up and down, noting the relationship between the blade and the side and back guide.
8. If the adjustment needs to be refined, repeat the procedure.

### **Troubleshooting**

#### **Bandsaw will not start**

1. Check that the start switch is being fully depressed.
2. Check that the red stop switch is fully out.
3. Check that the electrical power cord is plugged into the power outlet.
4. Check that the electrical supply is on (reset the breaker).
5. Check that the earth wire is wired correctly.
7. With the power disconnected from the machine, check that the wiring in the terminal box is correct.  
Check that the rubber insulation is stripped enough and is not causing a bad connection.  
Check that all the screws are tight.
8. Test the safety circuit. With the power disconnected from the machine, use a multi-meter/circuit tester to check that there is continuity between 5L3 (red wire) and the red wire beside 2T1. To gain access to the terminals, you will have to remove the switch plate from the front of the switch box. This circuit is a loop that has the foot brake and stop switch. It is designed to be fail-safe, and any switch that is not functioning or set correctly will cause the machine to not start. If there is no continuity, you will have to trace the switch that is open or faulty and correct the fault.
9. Check that you have the correct power: 220V, not 110V.

#### **The machine will not stop**

This is a very rare occurrence as the machine, is designed to be fail-safe. If it should occur and you cannot fix the fault, seek professional assistance. The machine must be disconnected from the power and never run until the fault has been rectified.

1. Stop switch faulty. Replace the stop switch.

2. Internal breaker faulty. Replace the breaker.

### **Motor tries to start but will not turn**

1. With the power disconnected from the machine, open the doors and try to turn the wheel by hand. If the wheel is not turning, check the reason for the jamming. Typical reasons are: guides too tight, wood jammed in the wheel.
2. Capacitor faulty. Replace the capacitor.
3. Motor faulty. Replace the motor.

### **Motor overheats**

The motor is designed to run very hot, but should it overheat, it has an internal terminal overload protector that will shut it down until the motor has cooled down, and then it will reset automatically. If the motor overheats, wait until it has cooled down and restart. If the motor shuts down constantly, instantly check for the reason. Typical reasons are dull blade, overfeeding the wood, motor cooling fan clogged or faulty, motor cooling fins clogged and excessive ambient temperature.

### **Squeaking noise**

1. Check that the motor cooling fan is not contacting the fan cover.
2. Check the bearings.
3. Check the drive belt.
4. Check that the guides are adjusted correctly.

### **Upper guide shaft is tight or loose**

1. Clean and lubricate.
2. Adjust rack and pinion.
3. Bent rack. Replace the rack.

### **Blade slows down during a cut**

1. Loose drive belt. Re-tension the belt.
2. Dull blade. Replace the blade or have it re-sharpened.

3. Feeding the wood too fast. Slow down the feed rate.
4. Insufficient set on the teeth (wood nipping the blade). Change blade for a blade with the correct set.
5. Oil or dirt on the drive belt. Clean or replace the drive belts.
6. Fence not aligned correctly. Align fence.

### **Blade will not track on fly wheels**

1. Bad blade. Change the blade.
2. Crown on the wheels worn or damaged tire. Dress the tires.

### **The blade kicks**

Bad blade. Replace the blade.

### **The blade makes a clicking noise**

Bad weld. Dress the weld or change the blade.

### **Blade overheats**

1. Dull blade. Change the blade or re-sharpen the blade.
2. Pitch is too small for the depth of cut. Change to a blade with the correct pitch.
3. Guides too tight. Adjust the guides.
4. Wood too hard for the selected blade. Change the blade.
5. Blade too thick for the diameter of the wheels. Change the blade.

### **Machine vibrates**

1. Machine not level on the floor. Re-level the machine, ensuring that it has no movement.
2. Damaged drive belt. Replace the belt.
3. Double drive belt system. Only one belt changed and the belts are not balanced. Replace both belts with a matched pair.

## Accessories

The following accessories are available from Laguna Tools.

Miter gage

Mobility kit.

Extension tables.

Work benches.

Bandsaw blades.

Cool blocks.

Large Laguna Guides.

Power feeder.

Drift master fence.

## Electrical system drawing

