









H-D® MOTORCYCLES BAR STOOL ASSEMBLY INSTRUCTIONS

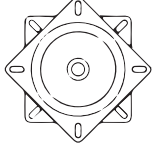

PARTS LIST

 <p>A x 1 Backrest</p>	 <p>B x 1 Legs</p>	 <p>C x 1 Column w/ Mounting Plate</p>	 <p>D x 1 Swivel</p>	 <p>E x 1 Seat w/Frame</p>	 <p>F x 4 Small Bolt w/Nut</p>	 <p>G x 4 Medium Bolt</p>
		 <p>H x 1 Large Allen Key</p>	 <p>I x 1 Large Bolt w/Washer</p>	 <p>J x 1 Small Allen Key</p>		

STEP 1

STEP 2

STEP 3

STEP 4

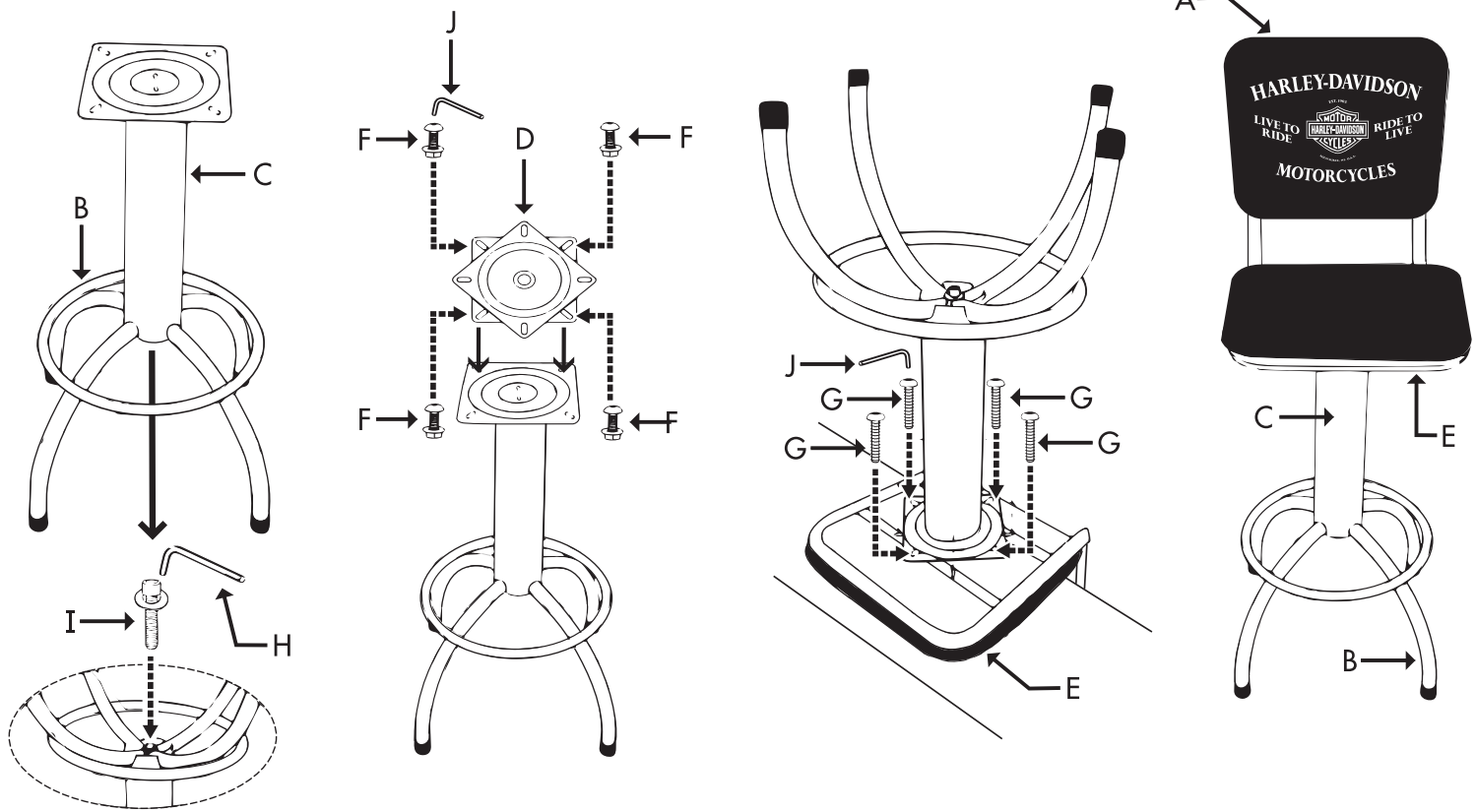

WARRANTY

Free replacement of any part that fails within 90 days from date of purchase, excluding shipping costs. Void if damaged by misuse, accidents, alterations, failure to follow instructions, fire, flood, and acts of God.

If you have any questions or comments, please contact us at: BrandedProducts.com



H-D, Harley, Harley-Davidson and the Bar & Shield Logo are among the trademarks of H-D Michigan, LLC.
 ©2015. All Rights Reserved. Manufactured by Ace Product Management Group, Inc. under license from Harley-Davidson Motor Company.
 For a dealer near you call toll free 1-800-588-2743 in the USA and Canada or use our dealer locator at www.harley-davidson.com

Ace Product Management Group, Inc.
 Milwaukee, WI U.S.A.