



**PLASTIC  
PRODUCTS  
MFG**

**Plastic Literature Holders and POP Displays**





**When Your  
Message Must Be  
Delivered, We'll  
Bend for You!**

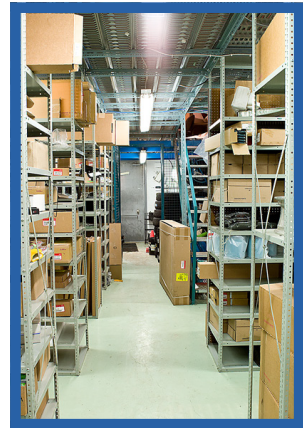

■ **Help Center**

■ **Sample Request Form**

■ **Fax Order Form**

■ **Quotation Request Form**

**Click to Visit Our Website**



**[www.plasticproductsmfg.com](http://www.plasticproductsmfg.com)**

# TABLE OF CONTENTS

<b>Acrylic Sign Holders</b> .....	<b>4</b>
Standard Series .....	5,6
Executive Series .....	7,8
Economy Series .....	9
<b>Acrylic Name Plates &amp; Vinyl Job Ticket Holders</b> .....	<b>10</b>
Name Plate Holder / Job Ticket Holder .....	11
<b>Acrylic Brochure Holders</b> .....	<b>12</b>
Single Pocket Wall Mount .....	13,14
Single Pocket Counter top.....	15,16
Multi-Tier / Multi Pocket / Counter top & Wall Mount.....	17,18,19
Outdoor Literature Holders.....	20
<b>Rigid Vinyl Economy Holders</b> .....	<b>21</b>
Brochure Holders / Attachable Brochure Pockets / Poster Holders.....	22
<b>Attachments and Accessories</b> .....	<b>23</b>
Double Face Tape, Velcro, Cam Lock, Hinge, Easel, Pad Lock, Key Hole Attachments .....	24
Z-Bar, Magnetic Catch & Buttons, Suction Cups, Screw Posts, Sign Base, Lazy Susan.....	25
<b>Acrylic Donation Boxes</b> .....	<b>26</b>
Donation Boxes / Money Banks and Coin Boxes .....	27
Suggestion / Comment & Ballot Boxes .....	28
<b>Business Card Holders</b> .....	<b>29</b>
Counter top / Wall Mount .....	30
Multi-Tier / Multi Pocket.....	31

Imprinting and custom fabrication available upon request



# Acrylic Sign Holders



# ACRYLIC SIGN HOLDERS

## STANDARD SERIES

### Style A - Acrylic Sign Holder

Clear .080 styrene. Side load.

Style AB features a business card attachment.

Style AP features a 4" Wide pocket Attachment.

Part No.	Wide	High
A050030CS	5"	3"
A035050CS	3½"	5"
A050070CS	5"	7"
A070050CS	7"	5"
A060080CS	6"	8"
A085110CS	8½"	11"
A110085CS	11"	8½"
A110140CS	11"	14"
A140110CS	14"	11"
A170110CS	17"	11"

Part No.	Wide	High
AP130110CSCO	13⅞"	11"
AP170110CSP	17"	11"
AP085110CS	8½"	11"
AP140110CSP	13"	11"
AP110085CSP	11"	8½"

Part No.	Wide	High
AB085110CSB	8 1/2"	11"

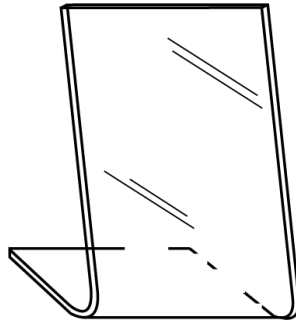

Style A

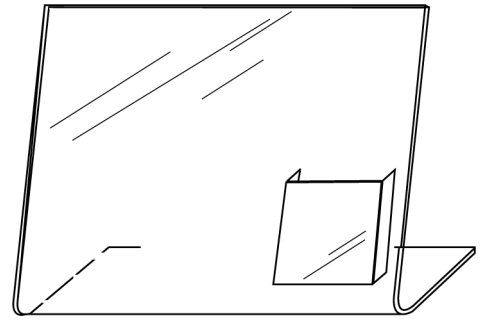

AP110085CSP

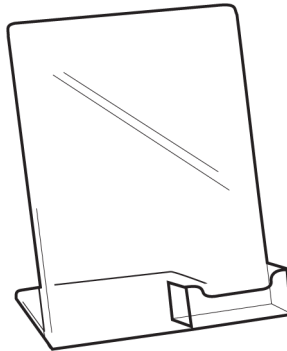

Style - AB085110CSB

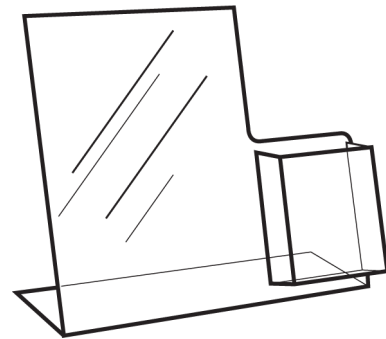

Style - AP130110CSCO

### Style B - Acrylic Display Stand

Clear .080 styrene. Top load.

Part No.	Wide	High
B035050CS	3½"	5"
B040060CS	4"	6"
B050070CS	5"	7"
B060080CS	6"	8"
B080100CS	8"	10"
B085110CS	8½"	11"
B110085CS	11"	8½"

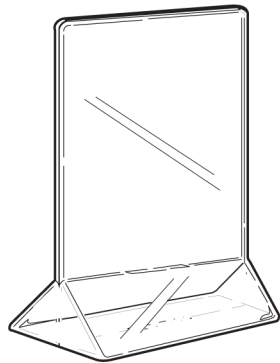

Style B

### Style C - Sign Display Holder

Clear .080 styrene. Bottom load.

Part No.	Wide	High
C040050CS	4"	5"
C040060CS	4"	6"
C050070CS	5"	7"
C080100CS	8"	10"
C085110CS	8½"	11"

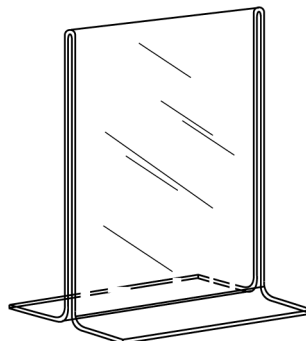

Style C



Click for all Sign Holders

# ACRYLIC SIGN HOLDERS

## STANDARD SERIES

### Style D6 - Lucite Sign Holder

Clear .080 styrene. Top load.

Part No.	Wide	High
D6040050	4"	5"
D6040060CS	4"	6"
D6050070CS	5"	7"
D6055085	5½"	8.5"
D6085110	8½"	11"

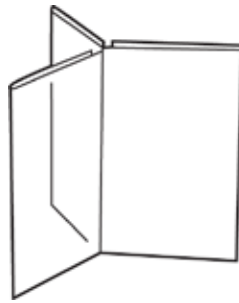

Style D6

### Style J - Acrylic Easels

Clear .080 styrene with 2" capacity.  
Style JB085110CSB features a business card attachment.

Part No.	Wide	High
J085110CS	8½"	11"
JB085110CS	8½"	11"



Style J

### Style Q - Counter top Menu Holder

Clear .080 Acrylic, Top load.

Part No.	For Sheet Size
Q040050	4"Wx5"H
Q040060	4"Wx6"H
Q040090	4"Wx9"H
Q050070	5"Wx7"H
Q085110	8½"Wx11"H

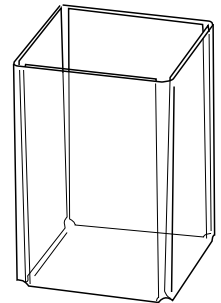

Style Q

### Style E - Open Book

Clear .080 styrene. Top load.

Part No.	Wide	High
E040060CS	4"	6"
E050070CS	5"	7"
E085110	8½"	11"

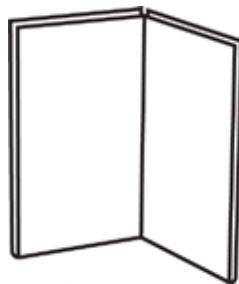

Style E

### Style W - Poster Holder

Clear .080 styrene. Top or side load.  
Includes pre-drilled holes. WB Features a business card Attachment.  
Also available with a flush top, no holes.

Part No.	For Sheet Size
W055085	5½" Wx8½"H
W085055	8½" Wx5½"H
W085110CS	8½" Wx11"H
W110085CS	11" Wx8½"H
W110140CS	11" Wx14"H
W140110CS	14" Wx11"H
W110170CS	11" Wx17"H
W170110CS	17" Wx11"H
WB085110CSB	8½" Wx11"H
WB140110CSB	14" Wx11"H
WB110085CSB	11" Wx8½"H



Style W

### Style F - Table Tent

Clear .080 styrene. Side load.

Part No.	Wide	High
F040060CS	4"	6"
F050070CS	5"	7"
F060040CS	6"	4"
F110035CS	11"	3 1/2"



Style F

### Style G - Hotel Sign Holder

Clear .080 styrene. Top load.

Part No.	Wide	High
G040060CS	4"	6"
G040090	4"	9"
G050070CS	5"	7"
G085110	8½"	11"



Style G



[Click for all Sign Holders](#)

Imprinting and custom fabrication available upon request

# ACRYLIC SIGN HOLDERS

## EXECUTIVE SERIES

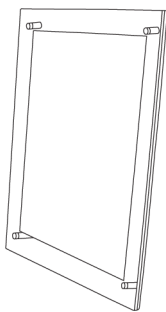

### Style W2 Wall Mount Beveled Edge Glass Green Sign Holder

May be displayed vertically or horizontally. Silver metal standoffs in each of the four corners. Provided with mounting brackets on back.

Part No.	For Sheet Size
W2040060CS GG	4" W x 6" H
W2050070CS GG	5" W x 7" H
W2085110CS GG	8 1/2" W x 11" H

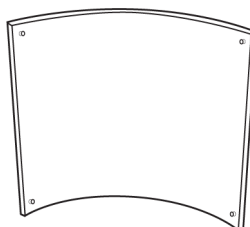

### Style SHC Clear Curved Sign Holders

**Clear acrylic**, may be used as a concave or convex sign or picture frame. Held together with magnets in each of the four corners.

**Black Back**, available only as a concave sign or picture frame. Held together with magnets in each of the four corners.

#### CLEAR BACK

Part No.	For Sheet Size
SHC060040CS	6" W x 4" H
SHC070050CS	7" W x 5" H
SHC110085CS	11" W x 8-1/2" H

#### BLACK BACK

Part No.	For Sheet Size
SHC060040CSB	6" W x 4" H
SHC070050CSB	7" W x 5" H
SHC110085CSB	11" W x 8-1/2" H

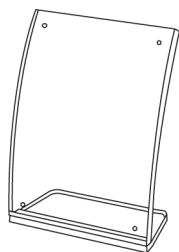

### Style A3 Arched Sign Frame

Clear acrylic. Features an elegant design with a removable magnetic faceplate that secures your signage in place and allows for effortless print changes. Features a removable base.

Part No.	For Sheet Size
A30305050CS	3-1/2" W x 5" H
A3040060CS	4" W x 6" H
A3050070CS	5" W x 7" H

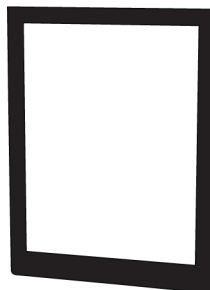

### Style WF BB Black Border Wall Mount Sign Holder

Clear acrylic, with a 1" black border around the frames perimeter. Key hole located on back for easy hanging.

Part No.	For Sheet Size
WF070050CS BB	7" W x 5" H
WF085110CS BB	8 1/2" W x 11" H
WF110085CS BB	11" W x 8 1/2" H

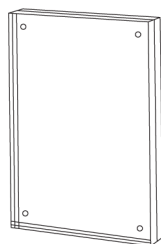

### Style WFT Super Thick Sign Frame

Clear acrylic 3/4" inch thick sign holder/photo frame. Panels held together with magnets, holds literature or photo in place.

Part No.	For Sheet Size
WFT035050CS	3-1/2" W x 5" H
WFT040060CS	4" W x 6" H
WFT050070CS	5" W x 7" H

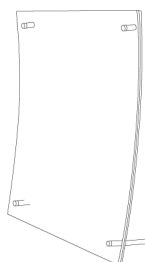

### Style A4 Bowed Sign Holder

Acrylic glass green edge. Display vertically or horizontally on counter top. Features removable silver standoffs in each corner.

Part No.	For Sheet Size
A4085110CS	8-1/2" W x 11" H
A4085110CS GG	8-1/2" W x 11" H Grn

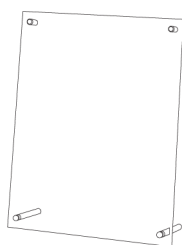

### Style A2

Removable silver knobs allow for a vertical or Horizontal display. Sleek, sophisticated, Durable, and lightweight.

Part No.	For Sheet Size
A2040060CS	4" W x 6" H
A2050070CS	5" W x 7" H
A2085110CS	8-1/2" W x 11" H

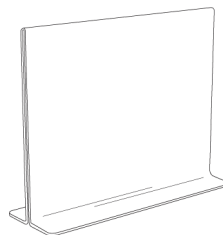

### Style C Glass Green Sign Holder

Glass green acrylic counter top sign holder. Load literature from the side or bottom. Polished with rounded edges on the base.

Part No.	For Sheet Size
C085110CS GG	8-1/2" W x 11" H
C110085CS GG	11" W x 8-1/2" H
C140110CS GG	14" W x 11" H

Click for all Sign Holders

Imprinting and custom fabrication available upon request

# ACRYLIC SIGN HOLDERS

## EXECUTIVE SERIES

### Style BS GG Swivel Base Sign Holder



Glass green sign holder / picture frame with heavy weight rotating satin metal base that remains stationary when manually rotated. Feature double sided viewing. Insert printed copy from top or sides

Part No.	For Sheet Size
BS040060CS GG	4" W x 6" H
BS050070CS GG	5" W x 7" H
BS085110CS GG	8-1/2" W x 11" H



### Style PE Elite Green Glass Trifold Brochure Holder

Acrylic with green edge, looks like glass. 2-1/8" capacity. Holds literature up to 4" wide..

Part No.	For Sheet Size
PE040080CS GG	4 1/8" W x 8" H



### Style BT Oval Base Sign Holder

Clear acrylic sign holder / picture frame with oval base in clear or black. Literature can be viewed from both sides. Insert printed copy, slides in from side or bottom.

Part No.	For Sheet Size
BT038082BCS black base	3-7/8" W x 8-1/4" H
BT038082CCS clear base	3-7/8" W x 8-1/4" H



### Style PE Elite Green Glass Full Sheet Brochure Holder

Acrylic with green edge, looks like glass. 3 1/4" capacity. Holds literature up to 8 1/2" wide..

Part No.	For Sheet Size
PE085110CS GG	8 1/2" W x 11" H



### Style A Black Border

Silk screened black border picture frame. Literature loads from sides. Slant back design. View from front side.

Part No.	For Sheet Size
A050070CS BB	5" W x 7" H
A085110CS BB	8-1/2" W x 11" H



[Click for all Sign Holders](#)



# ACRYLIC SIGN HOLDERS

## ECONOMY SERIES

### ECONOMY SERIES

#### Style A - Slanted

Clear .070 styrene. Side Load.

Part No.	Wide	High
A035050CSE	3½"	5"
A050070CSE	5"	7"
A085110CSE	8½"	11"
A110085CSE	11"	8½"

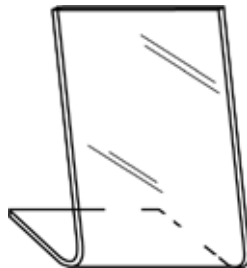

Style A



### ECONOMY SERIES

#### Style B - Top Load

Clear .070 styrene. Side or Top Load.

Part No.	Wide	High
B040060CSE	4"	6"
B050070CSE	5"	7"
B085110CSE	8½"	11"



Style B

### ECONOMY SERIES

#### Style C - Bottom Load

Clear .070 styrene. Side Load.

Delete line protects your signs from damage.

Part No.	Wide	High
C040060CSE	4"	6"
C050070CSE	5"	7"
C085110CSE	8½"	11"
C110085CSE	11"	8½"



Style C



### ECONOMY SERIES

#### Style W - Wall Mount

Clear .070 styrene. Side or top Load.

With pre drilled holes. Available with flush top, upon request.

Part No.	Wide / High
W085110CS	8 1/2" x 11"
W110085CS	11" x 8 1/2"

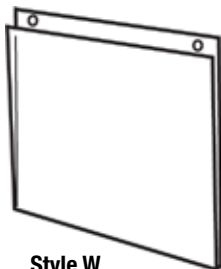

Style W

Click for all Sign Holders

Imprinting and custom fabrication available upon request

www.plasticproductsmfg.com • 1-800-611-6466

# Acrylic Name Plates & Vinyl Job Ticket Holders

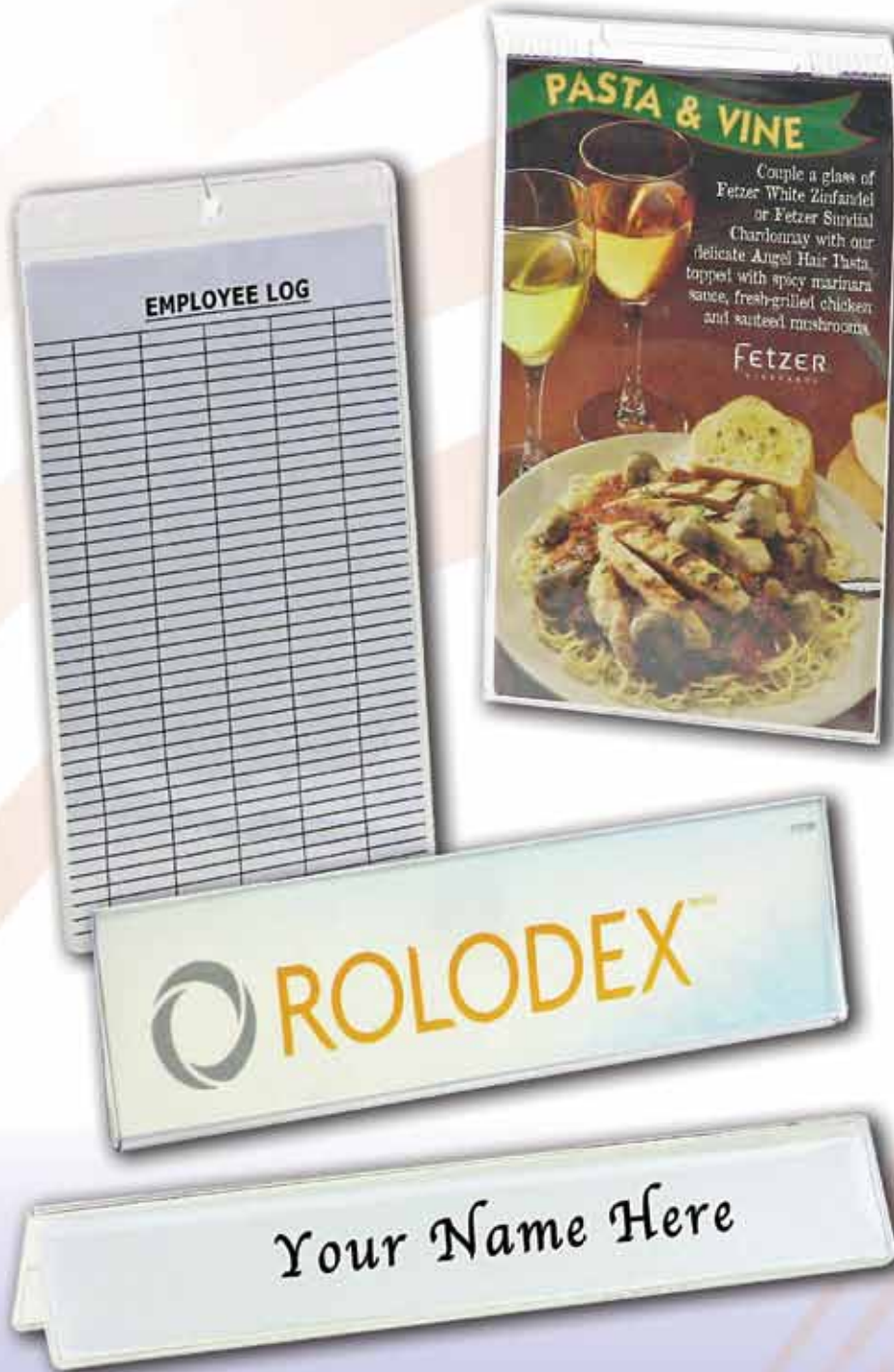

# ACRYLIC NAME PLATE HOLDERS / VINYL JOB TICKET HOLDERS

## NAME PLATE HOLDERS / JOB TICKET HOLDERS

### Style F Name Plate Holder

Clear Acrylic .080 thick double sided counter top table tent. Insert your name or message from either side. Other sizes available upon request. (Minimum order may apply)

Part No.	Width / Height
F030020	3" W x 2" H
F040020	4" W x 2" H
F085020	8 1/2" W x 2" H
F110020	11" W x 2" H
F110042	11" W x 4-1/4" H
F110035CS	11" W x 3-1/2" H



### Style WF

Clear Acrylic .080 Wall Mount Sign Holder. Insert your message from either side. Apply to surface with double sided tape, Velcro or magnetic strip. Other sizes available upon request. (Minimum order may apply)

Part No.	Width / Height
WF030020	3" W x 2" H
WF040020	4" W x 2" H
WF060020	6" W x 2" H
WF085020	8-1/2" W x 2" H
WF085022	8-1/2" W x 2-1/4" H

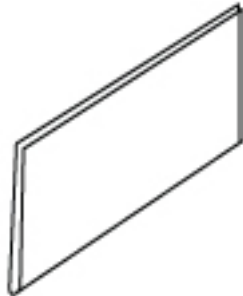

### Style FTT

White Hi Impact Styrene .040 thick double sided. Imprint, or you can apply a decal, for an additional charge.

Part No.	Width / Height
FTT030020	3" W x 2" H
FTT030040	3" W x 4" H
FTT040020	4" W x 2" H
FTT060020	6" W x 2" H
FTT085020	8-1/2" W x 2" H
FTT110020	11" W x 2" H



### Style A Name Plate Holder

Clear Acrylic .080 thick Slant Back name plate holder / sign holder. Insert your message from either side.

Part No.	Width / Height
A030010	3" W x 1" H
A030020	3" W x 2" H
A030025	3" W x 2-1/2" H
A035020	3-1/2" W x 2" H
A040015	4" W x 1-1/2" H
A040020	4" W x 2" H

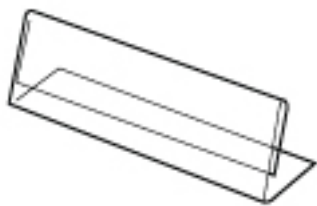

### Style PNH Sign Holder

Clear Acrylic .080 thick name plate or sign holder. Insert your message from either side. Hangs over 2" deep office partition.

Part No.	Width / Height
PNH060040	6" W x 4" H
PNH070050	7" W x 5" H
PNH085110	8-1/2" W x 11" H
PNH110020	11" W x 2" H
PNH110035	11" W x 3-1/2" H
PNH110040	11" W x 4" H
PNH11085	11" W x 8-1/2" H

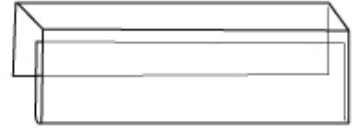

### Style VJTH

#### Vinyl Job Ticket Holder-

Clear flexible polished vinyl .075 mil thick. Comes with 1/4" diameter hole at the top for hanging. Open on short side, reinforced edges.

Part No.	Width / Height
VJTH040060	4" W x 6" H
VJTH090120	9" W x 12" H
VJTH095125	9 1/2" W x 12-1/2" H
VJTH060090	6" W x 9" H
VJTH038056	3-13/16 W x 5-5/8" H



### Style VSL AB

#### Adhesive Back Protective Sleeves

Clear flexible polished vinyl .075 mil thick with adhesive back. Open on short side. Attach to almost anything. (Minimum order applies)

Part No.	Width / Height
VSL025040 AB	2-1/2" W x 4" H
VSL038024 AB	3-13/16" W x 2-7/16" H
VSL041085 AB	4-1/8" W x 8-1/2" H
VSL044095 AB	4-7/16" W x 9-1/2" H
VSL090120 AB	9" W x 12" H



### Style VSL

#### Vinyl Protective Sleeves

Clear flexible polished vinyl .075 mil thick. Open on short side, can be ordered with eyelets or Velcro. Imprint your logo. (Minimum order applies)

Part No.	Width / Height
VSL025040	2-1/2" W x 4" H
VSL038024	3-13/16" W x 2-7/16" H
VSL041085	4-1/8" W x 8-1/2" H
VSL044095	4-7/16" W x 9-1/2" H
VSL090120	9" W x 12" H



Click for all Name Plate Holders

Imprinting and custom fabrication available upon request

www.plasticproductsmfg.com • 1-800-611-6466



# Acrylic Brochure Holders





# ACRYLIC BROCHURE HOLDERS

## SINGLE POCKET / WALL MOUNT



### PB740CS

Clear. For material up to 2-1/2"W.  
2-5/8"W x 2-1/2"H x 1" D  
With 1" capacity  
Imprint area is 2"W x 1"H

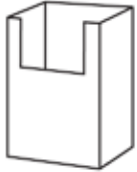

### PB426CS

Clear. For material up to 2-3/4"W.  
2-13/16"W x 4"H x 1-5/8" D  
With 1-1/2" capacity  
Imprint area is 2-1/4"W x 1-3/4"H



### PB600C

Clear. For material up to 2-1/2"W.  
3-7/16"W x 5"H x 3/4" D  
With 3/4" capacity  
Imprint area is 3"W x 7/8"H



### PB1800CS

Clear. For material up to 3-3/8"W.  
3-7/16"W x 2-3/4"H x 3/4" D  
With 3/4" capacity  
Imprint area is 2-3/4"W x 1"H



### PB200CS

Clear. For material up to 3-1/2"W.  
3-5/8"W x 7-1/4"H x 7/8" D  
with 7/8" capacity  
Imprint area is 3-1/2"W x 7/8"H



### PB640CS

Clear. For material up to 3-1/2"W.  
3-11-16"W x 4"H x 1-5/16" D  
With 1-3/4" capacity  
Imprint area is 2-3/4"W x 1-1/2"H



### PB1400CS

Clear. For material up to 3-3/4"W.  
3-3/4"W x 7"H x 1-5/8" D with 1-5/8"  
Capacity. Imprint area is 3-1/4"W x 2"H

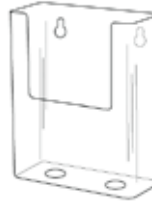

### PB1500CS

Clear. For material up to 3-3/4"W.  
3-7/8"W x 5"H x 1-5/8" D With  
1-1/2" capacity. Imprint area is 3-1/4"W x 1-1/2"H



### PB1600CS

Clear. For material up to 4"W.  
4-1/8"W x 7"H x 1-5/8" D with  
1-5/8" capacity. Imprint area is 3-1/2"W x 2"H



### PB1680CS

Clear. For material up to 4-1/4"W.  
4-3/8"W x 5"H x 1-5/8" D with 1-1/2" capacity. Imprint  
area is 3-1/2"W x 1-1/2"H

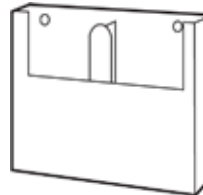

### PBS 1360 DCS - Plain w/ Divider

Clear. For material up to 4-1/2"W with divider,  
Using 2 compartments. 9-5/8"W x 8"H x 2" D  
with 1-7/8" capacity.  
Imprint area is 8-3/4"W x 4"H



[Click for all Wall Mount Brochure Holders](#)

# ACRYLIC BROCHURE HOLDERS

## SINGLE POCKET / WALL MOUNT



### PB1740CS

Clear. For material up to 4-3/4"W.  
4-7/8"W x 7"H x 2" D with 2" capacity.  
Imprint area is 3-3/4"W x 2"H



### PB1200CS

Clear. For material up to 8-1/2"W.  
8-3/4"W x 9-1/2"H x 2"D with 2" capacity.  
Imprint area is 7-3/4"W x 4-3/4"H

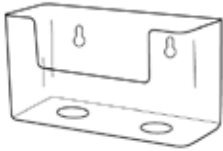

### PB1640CS

Clear. For material up to 5"W.  
5-3/16"W x 2-3/4"H x 1-7/16" D with  
1-3/8" capacity. Imprint area is 4-3/4"W x 1/2"H



### PB1280CS

Clear. For material up to 8-1/2"W.  
8-3/4"W x 9-1/2"H x 2"D with 4" capacity.  
Imprint area is 7-3/4"W x 4-3/4"H



### PB1700CS

Clear. For material up to 5-1/2"W.  
5-5/8"W x 5-1/2"H x 3-1/2" D  
With 3-1/2" capacity.  
Imprint area is 4-3/4"W x 1-3/4"H

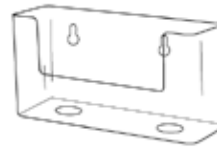

### PB1720CS PB1722CS - with Base

Clear. For material up to 8-3/4"W.  
8-7/8"W x 3-1/2"H x 2"D with 2" capacity.  
Imprint area is 7-3/4"W x 7/8"H



### PB1320CS

Clear. For material up to 5-13/16"W.  
5-15/16"W x 6-1/2"H x 1-5/8" D with  
1-1/2" capacity. Imprint area is 5"W x 2-3/4"H

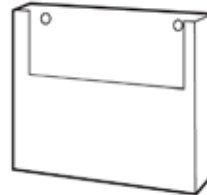

### PB1360CS

Clear. For material up to 9-1/2"W.  
9-5/8"W x 8"H x 2"D with 1-7/8" capacity.  
Imprint area is 8-3/4"W x 4"H

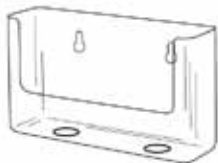

### PB1660CS

Clear. For material up to 6"W.  
6-1/8"W x 3-1/2"H x 1-1/2" D with 1-1/2" capacity.  
Imprint area is 5-1/2"W x 7/8"H

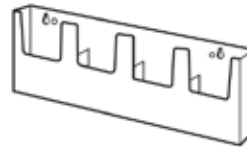

### PB1508W

White. For material up to 3-3/4"W.  
4 compartments.  
15-1/2"W x 5"H x 2-1/4" D with 1/2" capacity.  
Imprint area is 14-1/2"W x 1-3/4"H



### PB1300CS

Clear. For material up to 6-5/8"W.  
6-3/4"W x 7"H x 1-3/4" D with  
1-1/2" capacity. Imprint area is 5-1/2"W x 3-1/2"H

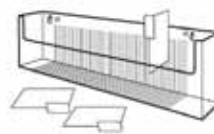

### PB1236CS

Clear. With 3 adjustable dividers to fit your ad  
Material. 18-1/2"W x 5"H x 2" D with 2" capacity.  
Imprint area is 17"W x 2-1/4" H



### PB1760C

Clear. For material up to 7-3/8"W.  
7-1/2"W x 2-3/4"H x 1" D with 15/16" capacity.  
Imprint area is 7"W x 2-1/4"H

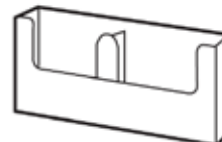

### PB1380C- Plain without Divider PB1380DC - with Divider

Clear. For material up to 4-1/2"W without divider.  
For material up to 9-1/2"W without divider.  
9-5/8" W x 4-3/4" H x 2"D with 1-3/4" capacity.  
Imprint area is 8-3/4" W x 1-1/2"H

Click for all Wall Mount Brochure Holders

[www.plasticproductsmfg.com](http://www.plasticproductsmfg.com) • 1-800-611-6466

# ACRYLIC BROCHURE HOLDERS

## SINGLE POCKET / COUNTERTOP

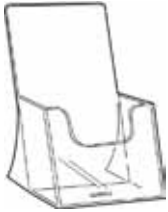

### PDK08D DEEP

Clear. For material up to 4" wide.  
4-1/2"W x 8-1/2"H x 4-9/16"D with 2-1/4" capacity.  
Imprint area is 4"W x 2-1/4"H



### PSTC040C

Clear. For material up to 4" wide.  
2" capacity. Features holes for mounting.  
4-1/4"W x 11-3/4"H with 2-1/4" capacity.



### PDK08D

Clear. For material up to 4" wide.  
4-1/2"W x 7-1/4"H x 3-1/4"D with 1-1/2" capacity.  
Imprint area is 3-3/4"W x 1-3/4"H



### PDK11D

Clear. For material up to 5-1/2" wide.  
5-5/8"W x 8-3/8"H x 3-1/2"D with 1-1/2" capacity.  
Imprint area is 5"W x 2-1/2"H



### PDK08CS

Clear. For material up to 4" wide.  
4-3/8"W x 7-3/4"H x 3-1/4"D with 1-5/8" capacity.  
Imprint area is 3-1/4"W x 1-1/2"H



### PDKB08CSB

Clear. For material up to 4" wide.  
Features holes for mounting.  
4-3/8"W x 7-3/4"H x 4"D with 1-5/8" Brochure  
capacity and 3/4" Business Card capacity



### PDK08SBCS

Clear. Low back. For material up to 4" wide.  
4-3/8"W x 3-7/8"H x 3-1/4"D with 1-5/8" capacity.  
Imprint area is 3-1/4"W x 1-1/2"H



### PDK17DCS

Clear. With divider. For material up to 4" wide.  
2 compartments. Feature holes for mounting.  
9 1/4" W x 10 3/4" H x 3 3/4" D with 1 1/2" Capacity. Imprint area is 8" W x 2 1/2" H



Click for all Single Pocket Countertop  
Imprinting and custom fabrication available upon request

[www.plasticproductsmfg.com](http://www.plasticproductsmfg.com) • 1-800-611-6466

# ACRYLIC BROCHURE HOLDERS

## SINGLE POCKET / COUNTERTOP



### PDK12D

Clear. For material up to 6" wide.  
6-1/2"W x 9-1/8"H x 3-1/2"D with 1-1/2" capacity.  
Imprint area is 5-1/2"W x 2-1/2"H

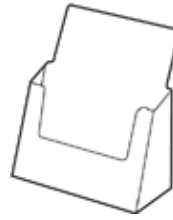

### PDK17D

Clear. For material up to 8-1/2" wide.  
8-7/8"W x 9-7/8"H x 4-1/4"D with 1-1/2" capacity.  
Imprint area is 8-1/4"W x 4"H



### PDK12CS

Clear. For material up to 6-3/8" wide.  
Features holes for mounting.  
6-3/4"W x 7-3/4"H x 3-3/4"D with 1-1/2" capacity.  
Imprint area is 5-1/2"W x 1-1/2"H



### PDK17SBCS

Clear. For material up to 8-1/2" wide. Low back.  
9-1/4"W x 7-1/2"H x 3-3/4"D with 1-1/2" capacity.  
Imprint area is 8"W x 2-1/2"H

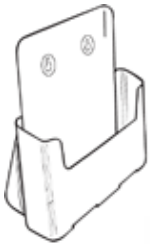

### PDK17CS

Clear. For material up to 8-1/2" wide.  
Features holes for mounting.  
9-1/4"W x 10-3/4"H x 3-3/4"D with 1-1/2" capacity.  
Imprint area is 8"W x 2-1/2"H

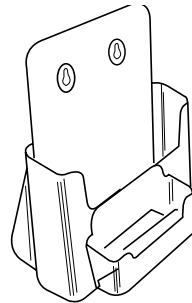

### PDKB17CSB

Clear. For material up to 8-1/2" wide.  
Features holes for mounting.  
9-1/4"W x 10-3/4"H x 4-1/2"D with 1-1/2" Brochure  
Capacity and 3/4" Business Card attachment can  
be located on either left or right side.



**Click for all Single Pocket Countertop**

**Imprinting and custom fabrication available upon request**

**www.plasticproductsmfg.com • 1-800-611-6466**



# ACRYLIC BROCHURE HOLDERS

## MULTI-TIER / MULTI POCKET / COUNTERTOP & WALL MOUNT

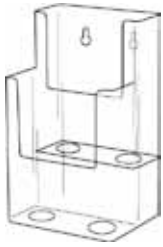

### **PB1404CS**

#### **Single Unit**

3-7/8"W x 7"H x 3-1/4"D  
With 1-1/2" capacity in each pocket.  
Imprint area is 3-1/2"W x 2"H.

Clear. For material up to 3-3/4"  
Wide. 2 compartments. Features  
Holes for mounting.

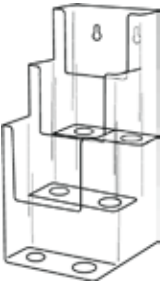

### **PB1406CS**

#### **Single Unit**

3-7/8"W x 9"H x 5"D  
With 1-1/2" capacity in each pocket.  
Imprint area is 3-1/4"W x 1/2"H.

Clear. For material up to 3-3/4"  
Wide. 3 compartments. Features  
Holes for mounting.



### **PB1406CS2**

#### **Double Unit (side by side)**

7-1/2"W x 9"H x 5"D  
With 1-1/2" capacity in each pocket.

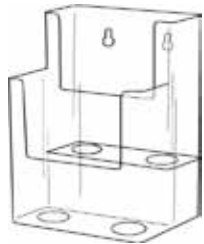

### **PB1604CS**

#### **Single Unit**

4-1/2"W x 7"H x 3-3/4"D  
With 1-3/4" capacity in each pocket.  
Imprint area is 3-1/2"W x 2"H.

Clear. For material up to 4-3/8"  
Wide. 2 compartments



### **PB1604CS2**

#### **Double Unit (side by side)**

9"W x 7"H x 3-3/4"D  
With 1-3/4" capacity in each pocket.



### **PB1606CS**

#### **Single Unit**

4-1/2"W x 9"H x 5-7/16"D  
With 1-3/4" capacity in each pocket.  
Imprint area is 3-1/2"W x 2"H.

Clear. For material up to 4-3/8"  
Wide. 3 compartments. Features  
Holes for mounting.



### **PB1606CS2**

#### **Double Unit (side by side)**

9"W x 9"H x 5-7/16"D  
With 1-3/4" capacity in each pocket.

**Click for all Multi-tier & Multi-pocket Brochure Holders**  
**Imprinting and custom fabrication available upon request**  
**[www.plasticproductsmfg.com](http://www.plasticproductsmfg.com) • 1-800-611-6466**

# ACRYLIC BROCHURE HOLDERS

## MULTI-TIER / MULTI POCKET / COUNTERTOP & WALL MOUNT



### PDK084CS

4-3/8"W x 8"H x 4"D  
With 1-15/16" capacity  
In each pocket.

Clear. For material up to 4" wide.  
2 compartments. Features holes  
For mounting.

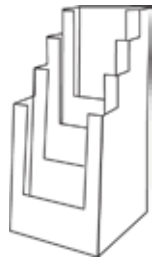

### PDK088D

4-1/4"W x 10"H x 5-3/4"D  
With 1-1/4" capacity  
In each pocket.

Clear. For material up to 4" wide.  
4 compartments



### PDK088CS

4-1/8"W x 10"H x 6"D  
With 1-1/8" capacity  
In each pocket.

Clear. For material up to 4" wide.  
4 compartments. Features holes  
For mounting.

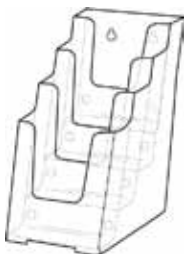

### PDK128CS

6-1/2"W x 10"H x 8"D  
With 1-1/8" capacity  
In each pocket.

Clear. For material up to 6-3/8"  
wide. 4 compartments. Features  
holes for mounting.

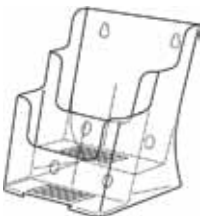

### PDK174CS

9-1/4"W x 11"H x 5"D  
With 1-3/4" capacity  
In each pocket.

Clear. For material up to 8-1/2"  
wide. 3 compartments.  
For counter top or wall mount use.



### PDK176CS

9"W x 13 3/4"H x 7 1/2"D  
with 1 1/2" capacity in each  
pocket.

Clear. For material up to  
8-1/2" wide. 3 compartments.

**Click for all Multi-tier & Multi-pocket Brochure Holders  
Imprinting and custom fabrication available upon request**

**[www.plasticproductsmfg.com](http://www.plasticproductsmfg.com) • 1-800-611-6466**

# ACRYLIC BROCHURE HOLDERS

## MULTI-TIER / MULTI POCKET / COUNTERTOP & WALL MOUNT

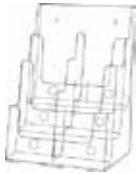

### PDK176DCS

9-3/8"W x 13-1/2"H x 7"D  
With 1-1/4" capacity  
In each pocket.

Clear. For material up to 4"  
Wide. 6 compartments. Features  
holes for mounting.



### PDK178DCS

9-1/4"W x 13-3/8"H x 7"D  
With 1-1/8" capacity  
In each pocket.

Clear. For material up to 4"  
Wide. 8 compartments. Features  
holes for mounting.



### PDK088CS2

8-1/4"W x 10"H x 8"D  
With 1-1/8" capacity  
In each pocket.

Clear. For material up to 4" wide.  
8 compartments.

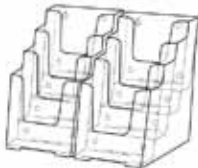

### PDK128CS2

13"W x 10"H x 8"D  
With 1-1/8" capacity  
In each pocket.

Clear. For material up to 6" wide.  
8 compartments.



### PDK176CS

9-3/8"W x 13-1/2"H x 7"D  
With 1-1/4" capacity  
In each pocket.

Clear. For material up to 8-1/2"  
wide. 3 compartments. For  
Counter top or wall mount use.



### PDK178CS

9-1/4"W x 13-3/8"H x 7"D  
With 1-1/8" capacity  
In each pocket.

Clear. For material up to 8-1/2"  
Wide. 4 compartments. Features  
holes for mounting.



### PDK176CS2

19"W x 12-5/8"H x 8"D  
With 1-1/4" capacity  
In each pocket.

Clear. For material up to 8-1/2"  
wide. 6 compartments.

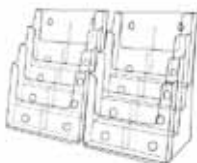

### PDK178CS2

18-1/2"W x 13-3/8"H x 7"D  
With 1-1/8" capacity  
In each pocket.

Clear. For material up to 8-1/2"  
wide. 8 compartments.



[Click for all Multi-tier & Multi-pocket Brochure Holders](#)

# ACRYLIC BROCHURE HOLDERS

## OUTDOOR LITERATURE HOLDER



### **POBH4X9**

#### **Outdoor Literature Holder**

Clear lid. For literature 4"W x 9"H.  
Lid protects literature from the elements.  
4-1/8"W x 10"H x 2"D with 1-1/2" capacity.



### **POBH TRIFOLD**

#### **Outdoor Literature Holder**

White lid. For literature  
4"W x 9"H. Lid protects literature from  
The elements. Has key hole attachment  
mounted on back.  
3-3/8"W x 8-3/4"H x 4-1/2"D with  
2 3/4" capacity.



### **POBH7X3**

#### **Outdoor Literature Holder**

White lid. For literature 7"W x 3"H.  
Lid protects literature from the elements.  
7-1/4"W x 3-1/8"H x 2"D with 2" capacity.



### **POBH4**

#### **Outdoor Literature Holder**

White with clear front. For material up to  
8-1/2"W x 11"H. Lid protects literature  
from the elements. Mounting hardware  
included. 9-1/2"W x 13"H x 4"D with 7/8"  
capacity.



### **POBH9X4**

#### **Outdoor Literature Holder**

White lid. For literature 9"W x 4"H.  
Lid protects literature from the elements.  
9-1/4"W x 4-1/2"H x 2"D with 2" capacity.



### **POBH4CS**

#### **Outdoor Literature Holder**

Clear with black lid. For material up to  
8-1/2"W x 11"H. Lid protects literature from  
the elements. Mounting hardware included.  
9-1/2"W x 12"H x 3"D with 2-3/8" capacity.



**Click for all Outdoor Brochure Holders**

**Imprinting and custom fabrication available upon request**

**[www.plasticproductsmfg.com](http://www.plasticproductsmfg.com) • 1-800-611-6466**



# Rigid Vinyl Economy Holders



# RIGID VINYL ECONOMY HOLDERS

## BROCHURE HOLDERS / ATTACHABLE BROCHURE POCKETS / POSTER HOLDERS

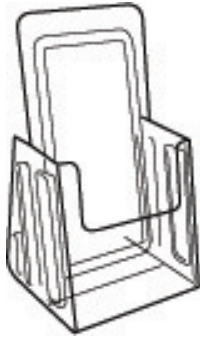

### Tri-Flat Brochure Holder

Clear Rigid Vinyl .030 thick pre-folded, imprinting available upon request.

Part No.	Width / Height
PPDK08 Folded	4-1/8" W x 7-1/2" H

### Tri-Flat Brochure Holder

Clear Rigid Vinyl .030 thick Ships Flat, Imprinting available upon request.

Part No.	Width / Height
PPDK08 Flat	4-1/8" W x 7-1/2" H

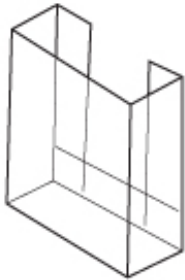
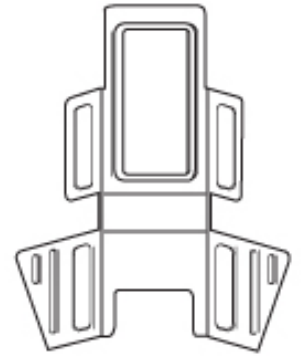

### Vinyl Brochure Pockets

Clear Rigid Vinyl .030 thick pre-folded, imprinting available upon request. Comes with double sided tape for attaching to almost any surface or substrate.

Part No.	Width / Height
VP035015 Folded	3-1/2" W x 1-1/2" H
VP040050 Folded	4" W x 5" H
VP045050 Folded	4-1/2" W x 5" H
VP060050 Folded	6" W x 5" H
VP085070 Folded	8-1/2" W x 7" H

### Vinyl Brochure Holder Pockets

Clear Rigid Vinyl Ships Flat .015 thick comes With double sided adhesive tape for attaching to almost any surface or substrate.

Part No.	Width / Height
VP035015	3-1/2" W x 1-1/2" H
VP040050	4" W x 5" H
VP045050	4-1/2" W x 5" H
VP060050	6" W x 5" H
VP085070	8-1/2" W x 7" H

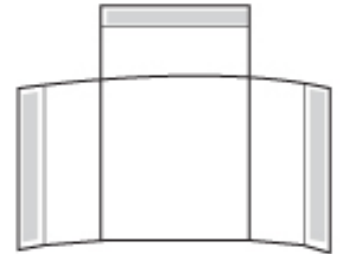

### Vinyl Poster Holders

Clear Rigid Vinyl .070 thick Holds posters up to .030 thick 3 sides are enclosed, open at the top of the "short side".

Part No.	Width / Height
VW040060	4" W x 6" H
VW050070	5" W x 7" H
VW080100	8" W x 10" H
VW085110	8-1/2" W x 11" H
VW110140	11" W x 14" H
VW110170	11" W x 17" H
VW160200	16" W x 20" H
VW240300	24" W x 30" H
VW240360	24" W x 36" H

### Poster Holder Accessories

Clear Rigid Vinyl .070 thick Holds posters up to .030 thick 3 sides are enclosed, open at the top of the short side. Specify with holes, Velcro, Z bar, double sided tape or Magnetic Strip for mounting.

Part No.	Width / Height
VW040060	4" W x 6" H
VW050070	5" W x 7" H
VW080100	8" W x 10" H
VW085110	8-1/2" W x 11" H
VW110140	11" W x 14" H
VW110170	11" W x 17" H
VW160200	16" W x 20" H
VW240300	24" W x 30" H
VW240360	24" W x 36" H

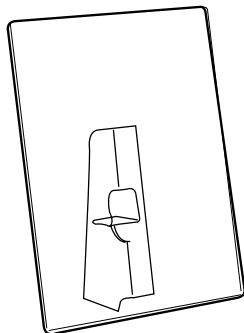
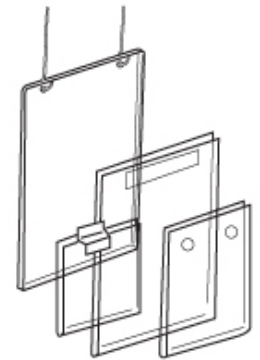

### Vinyl Sign Holder

Clear Slant Back Rigid Vinyl Sign Holder. 3 sides are enclosed, open at the top "short side". Use them anywhere - These Plastic Sign Holders mount to any wall or use the foldable easel on back for countertop use.

Part No.	Width / Height
VA030040	3"W x 4"H
VA040060	4"W x 6"H
VA050070	5"W x 7"H
VA085110A	8-1/2"W x 11"H

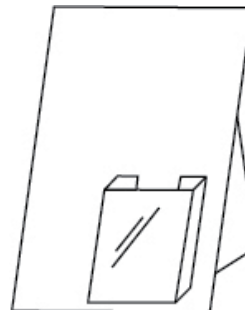

### Vinyl Sign Holder with Pocket

Clear Slant Back Vinyl Sign Holder, with brochure pocket 4" Wide x 5" High x 1-1/4" Deep. 3 sides enclosed, open on the short side. Use them anywhere. These plastic sign holders mount to any wall or use the foldable easel on back for countertop use.

Part No.	Width / Height
VA085110AP	8-1/2"W x 11"H

# Attachments and Accessories



# ATTACHMENTS AND ACCESSORIES

## DOUBLE FACE TAPE, VELCRO, CAM LOCK, HINGE, PAD LOCK, KEY HOLE ATTACHMENTS

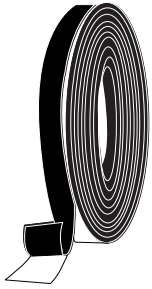

### Magnetic Strip Tape

Mount warehouse signs and markers to metal racking, file cabinets or doors. Standard widths 1/2" & 1" x 1/16" thickness x 100 ft. rolls. Specify width, length and number of pieces to be applied to each part.

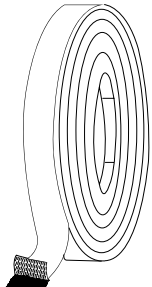

### Double Face (Foam) Tape

Securely bond temporary POP displays, signage and artwork to a variety of surfaces. Standard widths 1/2" 3/4" & 1" x 1/16" thickness x 108 ft. rolls. Specify width, length and number of pieces to be applied to each part.

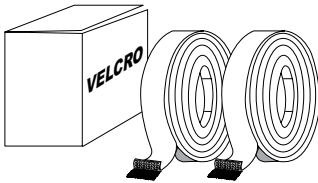

### Velcro - Hook and Loop

Hang signs, POP displays, mount display boards etc. Adhesive backed. Hook and loop sold separately. Standard widths 1/2" 3/4" & 1" x 1/16" thickness x 75 ft. rolls. Specify width, length and number of pieces to be applied to each part.

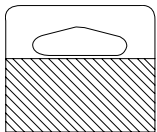

### Hang Tab

Easy-to-use pre-cut clear hang tabs, turn POP displays and small boxes into display items. Permanent adhesive. Flexible backing sticks to irregular surfaces.

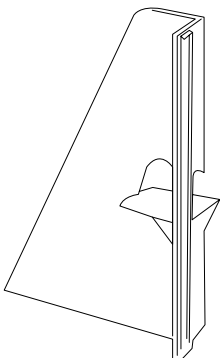

### Attachable Easel

Made of high impact clear PETG for durability. .040 thickness, comes with adhesive back, just peel and stick. Single wing. Use both vertically and/or horizontally. Supports heights up to 11".

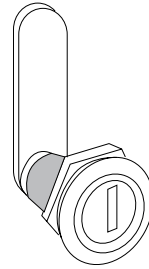

### Cam Lock

Use on Donation and Suggestion boxes or just about any POP display that requires security. Comes with 2 single bitted brass keys. Guards against theft, vandalism, sabotage and unauthorized use

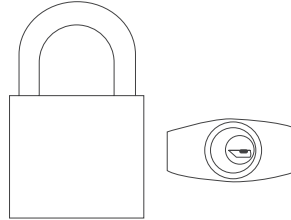

### Padlock

Used on our Donation, Suggestion boxes in conjunction with our clear hasp to protect against theft, vandalism, sabotage, and unauthorized use.

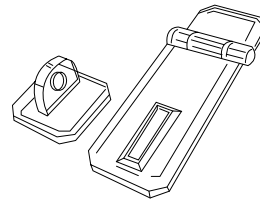

### Clear Hasp

(Comes without lock) No drilling or riveting required. Can be solvent cemented to acrylic and other types of plastic sheet. Measure 1-1/16" wide x 2-3/8" long and is available in clear only. See brass padlock to use in conjunction with hasp.

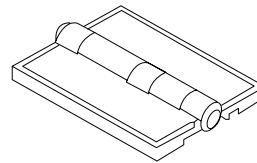

### Acrylic Hinge

Bondable to acrylic, ABS, Hi Impact Styrene, Poly carbonate and more. Size 1-1/2" x 1-3/4" Deep x 1/16" High. Made of clear DR acrylic.

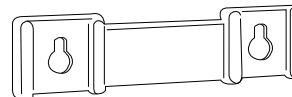

### Keyhole Frame Hanger x 2

Easily cemented to acrylic displays and fixtures.

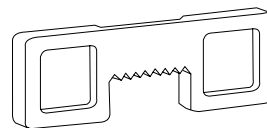

### Sawtooth Frame Hanger

Made of clear acrylic, perfect for used on our acrylic picture frames and poster holders. 2-3/16" Wide x 3/4" High x 1/4" Deep.

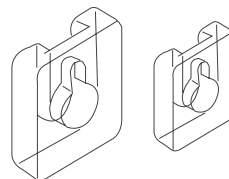

### Keyhole Attachment

Clear acrylic 1-1/4" Wide x 1/4" thick. Used on the back side of our acrylic picture frames and poster holders.

[Click for all Attachments & Accessories](#)

Imprinting and custom fabrication available upon request

[www.plasticproductsmfg.com](http://www.plasticproductsmfg.com) • 1-800-611-6466



# ATTACHMENTS AND ACCESSORIES

## Z-BAR, MAGNETIC CATCH & BUTTONS, SUCTION CUPS, SCREWS, SIGN BASE, LAZY SUSAN

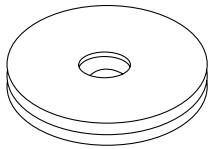

### Turn Tables

Clear or white styrene. Quiet and free running turntable, base rotates on 4 1/4" diameter base x 9/16" thick. Use on standard or custom POP displays.

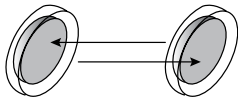

### Magnetic Button

3/4" diameter, glues on the back side of the acrylic sign holders, picture frame or poster holders. Then attach directly to any ferrous metal. Strong holding power and easily removed.

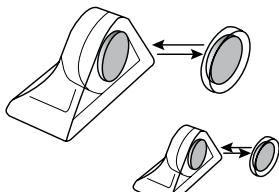

### Magnetic Catch

The only magnetic door catch that is solvent bondable to a display without screws or rivets.

**Sizes:** Small 7/8" L x 3/8" H  
Large 1-3/4" L x 3/8" W x 3/4" H

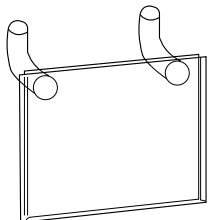

### Pegboard Hook

Clear acrylic DR hook for Pegboard and slat wall applications.

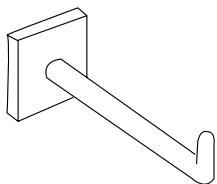

### Peg Hook

1/8" diameter x 1", 2" and 3" long. Bondable polyester. Adheres to acrylic, ABS, Styrene and Poly carbonate. Flat hooks also available upon request.

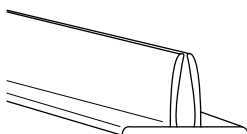

### Sign Base Card Holder

Clear PVC 1-3/4" and 3" wide base. Accepts material up to .093 thickness. Specify length when ordering.

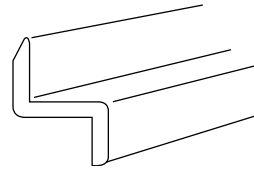

### Z Bar Attachment

Clear acrylic DR 1/2" x 1/2" x 72" lengths. Can be cut to specific sizes. For hanging literature holders, brochure holders, sign holders and other various displays on slat wall hanger systems.



### Bump-ons

Clear polyurethane with pressure sensitive adhesive backing. Available in 3/8" or 1/2" round and 1/2" flat. Helps prevent display from scratching and movement on counter tops.

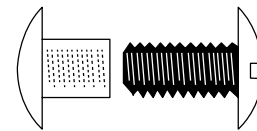

### Screw Posts

(Sandwich Frame Screws) Made of clear PETG. Bind sandwich frames together. For mounting picture frames and poster frames on walls. 6 sizes available. All are 8/32" diameter x 1/4", 3/8", 1/2", 5/8", 3/4" and 7/8" long.

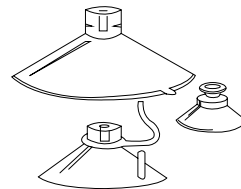

### Suction Cups

Four types available, 3/4", 1-5/8", 2-1/2" Diameters. Also available with metal hook, 1-5/8" Diameter Mushroom Head. Use on freezer doors or glass windows for displaying marketing materials etc.



Click for all Attachments & Accessories

Imprinting and custom fabrication available upon request

www.plasticproductsmfg.com • 1-800-611-6466

# Acrylic Donation Boxes



# ACRYLIC DONATION BOXES

## DONATION BOXES / MONEY BANKS AND COIN BOXES

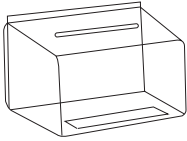

### **PMBSC2** **Mini Coin Bank**

Clear styrene. Overall size - 5" Wide x 3" High x 3-1/4" Deep. Slot size is 2 3/4"W x 3/8" Deep ( Jonnie reduce the size to match PMBSC6H below)

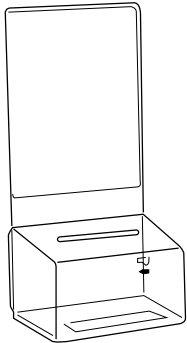

### **PMBSC6H** **Mini Coin Bank**

Clear Lexan. Overall size 5" Wide x 3 7/8" High x 3 5/8" Deep. Header (Sign Holder) holds a 5 x 7 insert, comes with set screw and hex key, Slot size is 2 7/8 "W x 1/4" Deep.

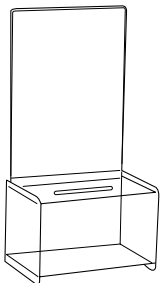

### **PMBSC3H** **Mini Coin Bank**

Clear acrylic. Overall size 5-1/2" Wide x 3" High x 3-5/8" Deep. Header (Sign Holder) holds 5" Wide x 7" High insert. Optional add on's business card holder or small brochure pocket.

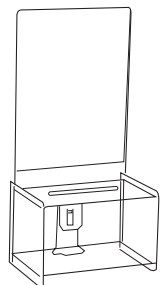

### **PMBSC5H** **Coin Box**

Clear acrylic Coin box with lock and sign holder. Overall size 5 3/8" x 3: High x 3-5/8" Deep. Locks on back. Ensures security of its contents. Header (Sign Holder) holds 5" Wide x 7" High insert.

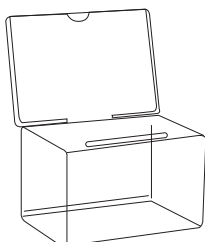

### **PMBSC7H** Coin Box

Clear acrylic. Overall size 6-1/8" Wide x 4-3/8" High x 4-3/8" Deep. Slot size 3-3/8" x 1/4". Header (Sign Holder). Holds 6" Wide x 4" High insert.

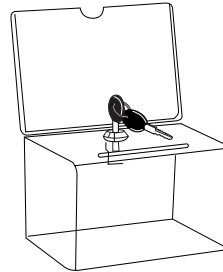

### **PMBSC7LH** **Coin Box**

Coin box with lock and sign holder. Clear acrylic. Overall dimension 6-1/8" Wide x 4 3/8" High x 4-3/8" Deep. Slot size 3-3/8" x 1/4". Header (Sign Holder). Holds 6" Wide x 4" High insert.

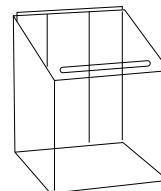

### **PBS01CS** **Coin Box**

Clear acrylic comment or coin box. Locks in back with cable Tie. Overall dimensions, 5-1/4" Wide x 6-1/2" High x 5-7/8" Deep. Slot size 3-7/8" x 3/8".

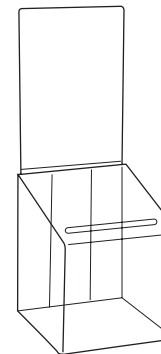

### **PBS01HCS** **Coin Box**

Clear acrylic comment or coin box. Locks in back with cable Tie. Overall dimensions, 5-1/4" Wide x 6-1/2" High x 5-7/8" Deep. Slot size 3-7/8" x 3/8". Header (Sign Holder) holds 5" Wide x 7" High insert.



### **PBS03CS** **Coin Box**

Smoke acrylic comment or coin box. Locks on the bottom. Overall dimensions, 6 1/2" Wide x 8-1/2" High x 6 1/4" Deep. Slot size 3-7/8" x 3/8".

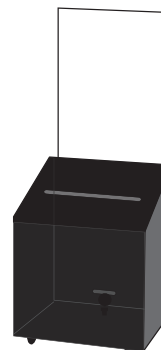

### **PBS03HCS** **Coin Box**

Smoke acrylic comment or coin box. Locks on the bottom. Overall size 6-1/2" Wide x 8-1/2" High x 6-1/4" Deep. Header (Sign Holder) holds 6" Wide 8" High insert.

**Click for all Money Banks & Coin Boxes**  
**Imprinting and custom fabrication available upon request**

# ACRYLIC DONATION BOXES

## SUGGESTION / COMMENT & BALLOT

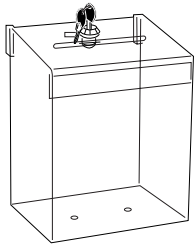

### **PBS02CS** **Coin Box**

Clear acrylic comment or coin box. Locks on top. Overall size 6-7/8" Wide x 8-3/4" High x 5" Deep.

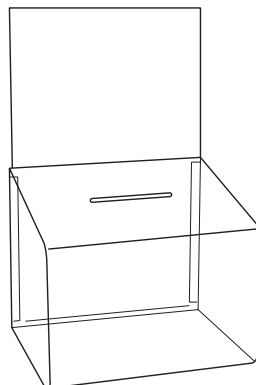

### **PBS09H** **Ballot Box**

Clear acrylic ballot box. Extra large overall size 11-3/8" Wide x 9-1/2" High x 8-3/4" Deep. Slot size 4-1/4" x 3/8". Header (Sign Holder) holds 11" Wide x 8 1/2" High insert.

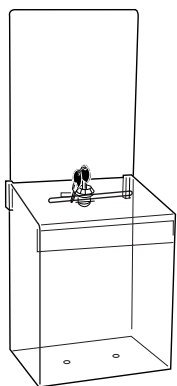

### **PBS02HCS** **Coin Box**

Clear acrylic comment or coin box. Locks on top. Overall size 6-7/8" Wide x 8-3/4" High x 5" Deep. Header (Sign Holder) holds 6" Wide x 8" High insert.

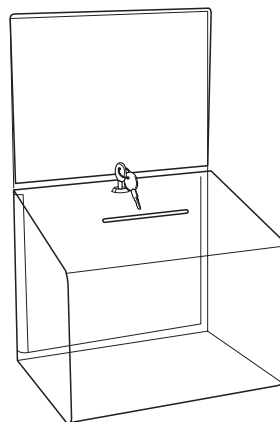

### **PBS09LH** **Ballot Box**

Clear acrylic ballot box with key. Locks on top. Extra large overall size 11-3/8" Wide x 9-1/2" High x 8-3/4" Deep. Slot size 4-1/4" x 3/8". Header (Sign Holder) holds 11" Wide x 8-1/2" High insert.

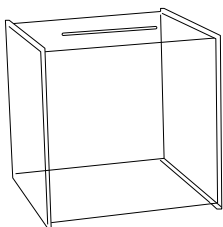

### **PBS04CS** **Ballot Box**

Clear acrylic ballot box. Overall size 8-3/8" Wide x 8-3/8" High x 8-3/8" Deep.

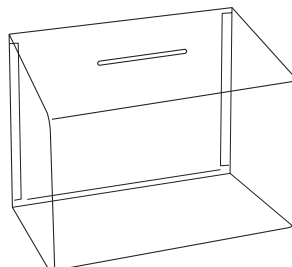

### **PBS09** **Ballot Box**

Clear acrylic Ballot Box, Extra large overall size 11-3/8" Wide x 9-1/2" High x 8-3/4" Deep. Slot size 4-1/4" x 3/8".

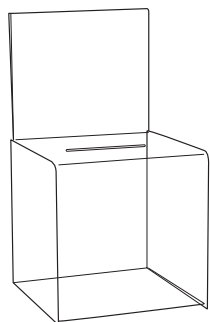

### **PBS04HCS** **Ballot Box**

Clear acrylic ballot box. Overall size 8-3/8" Wide x 8-3/8" High x 8-3/8" Deep. Header (Sign Holder) holds 8" Wide x 7" High insert.

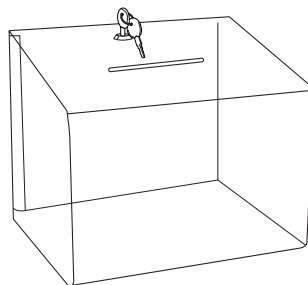

### **PBS09L** **Ballot Box**

Clear acrylic Ballot Box with key. Locks on top. Extra large overall size 11-3/8" Wide x 9-1/2" High x 8-3/4" Deep. Slot size 4-1/4" x 3/8".

**Click for all Suggestion / Comment / Ballot Boxes**

**Click for hand fabricated Ballot & Suggestion Boxes**

**Imprinting and custom fabrication available upon request**



# Business Card Holders





# BUSINESS CARD HOLDERS

## COUNTERTOP / WALL MOUNT

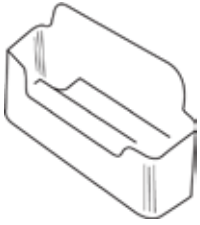

### **PCSS110CSB** **Business Card Holder**

Black. Holds over 65 cards.  
For counter top use.



### **PB100CS** **Business Card Holder**

Clear. For counter top use.  
Has a high back for imprinting your logo  
3 3/4" Wide x 4" High x 3/4" Deep  
Imprint area 3" Wide x 2 1/2"

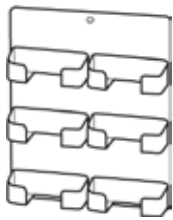

### **PMB06B** **Multi-Compartment Wall Mount Business Card Holder**

Black. 6 compartments. Features  
Holes for mounting to walls.

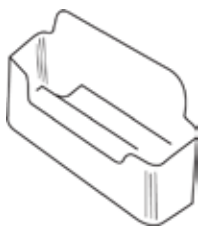

### **PCSS110CS** **Business Card Holder**

Clear. For counter top use.

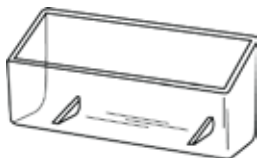

### **PB110CS** **Business Card Holder**

Clear. Attaches to any literature holder,  
sign frame and more. Comes with  
adhesive back upon request.



**Click for all Countertop Business Card Holders**  
**Imprinting and custom fabrication available upon request**  
**[www.plasticproductsmfg.com](http://www.plasticproductsmfg.com) • 1-800-611-6466**

# BUSINESS CARD HOLDERS

## MULTI-TIER / MULTIPOCKET

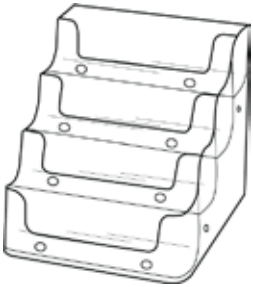

**PB1108CSB**  
**Multi-Tier**  
**Business Card Holder**

Black. 4 compartments. Also available in 8, 12, 16 and 24 compartments.



**PS150**  
**Vertical Business Card Holder**

Clear. For counter top use.

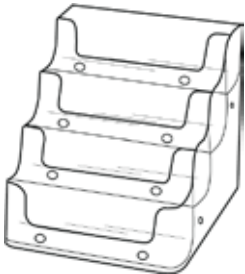

**PB1108CS**  
**Multi - Tier**  
**Business Card Holder**

Clear. 4 compartments. Also available in 8, 12, and 16 compartments.

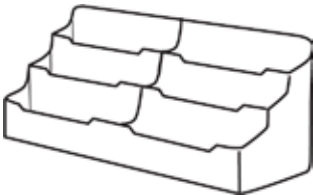

**PB112C**  
**Multi-Tier**  
**Business Card Holder**

Clear. 6 compartments.

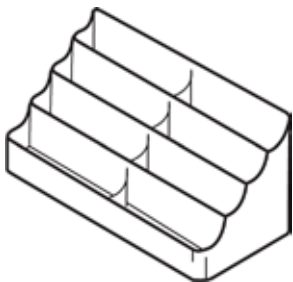

**PB1108CSB2**  
**Multi-Tier**  
**Business Card Holder**

Black. 8 compartments.



**Click for all Multi-tier / Multi Pocket Countertop Business Card Holders**  
**Imprinting and custom fabrication available upon request**



ECO-CONSCIOUS MANUFACTURERS  
**RECYCLED MATERIALS**  
SAVES TREES & LANDFILLS



[www.plasticproductsmfg.com](http://www.plasticproductsmfg.com)  
**1-800-611-6466**  
**Fax: 714-524-8145**