

Kawasaki
Engines

FJ180V

4-Stroke Air-Cooled V-Twin Gasoline Engine

OWNER'S MANUAL

Part No. 99920-2254-03

SAFETY AWARENESS

Whenever you see the symbols shown below, heed their instructions!

Always follow safe operating and maintenance practices.

▲ WARNING

This warning symbol identifies special instructions or procedures which, if not correctly followed, could result in personal injury, or loss of life.

CAUTION

This caution symbol identifies special instructions or procedures which, if not strictly observed, could result in damage to, or destruction of equipment.

NOTE

- *This note symbol indicates points of particular interest for more efficient and convenient operation.*

FOREWORD

Congratulations on your purchase of a new Kawasaki engine.

Please read this Owner's manual carefully before starting your new engine so that you will be thoroughly familiar with the proper operation of your engine's control, its features, capabilities and limitations.

Also read the manual of the equipment to which this engine is attached .

To ensure a long, trouble-free life for your engine, give it the proper care and maintenance described in this manual.

Always keep this manual at your fingertip so that you can refer to it whenever you need information.

This manual should be considered a permanent part of the engine and should remain with the engine when it is sold.

All rights reserved. No part of this publication may be reproduced without our prior written permission.

This publication includes the latest information available at the time of printing.

However, there may be minor differences between the actual product and illustrations and text in this manual. All products are subject to change without prior notice or obligation.

**Kawasaki Heavy Industries, Ltd.
Consumer Products & Machinery Company**

TABLE OF CONTENTS

READ THIS FIRST.....	2
EMISSION CONTROL.....	3
INFORMATION	
GENERAL INFORMATION.....	6
FUEL AND OIL.....	8
RECOMMENDATIONS	
PREPARATION.....	9
Fuel.....	9
Engine Oil.....	9
STARTING.....	10
Starting Engine.....	10
WARMING UP.....	12
OPERATING.....	12
Engine Inclination.....	12
STOPPING.....	12
Stopping Engine.....	12
ADJUSTMENT.....	13
Engine Speed Adjustment.....	13
MAINTENANCE.....	14
Periodic Maintenance Chart.....	14
Oil Level Check.....	15
Oil Change.....	15
Oil Filter Change(if equipped).....	16
Air Cleaner Service.....	17
Spark Plug Service.....	19
STORAGE.....	20
TROUBLESHOOTING GUIDE.....	21
ENVIRONMENTAL PROTECTION.....	22
SPECIFICATIONS.....	23

READ THIS FIRST

For your safety, read this Owner's Manual and understand it thoroughly before operating this ENGINE.

WARNING

- Never allow children to operate the engine or equipment.
- Keep people and pets out of areas where you are using the engine or equipment.
- Never wear loose, torn, or bulky clothing. It may catch on moving parts or controls, leading to the risk of accident.
- Never consume alcohol or drugs before or while operating this engine
- Do not run the engine in a closed area. Exhaust gas contains carbon monoxide, an odorless and deadly poison.
- Gasoline is extremely flammable and can be explosive under certain conditions.
 - Stop engine and allow the engine to cool before refueling.
 - Do not smoke. Make sure the area is well ventilated and free from any source of flame or sparks including the pilot light of any appliance while refueling, servicing fuel system, draining gasoline and/or adjusting carburetor.
 - Do not fill the tank so the fuel level rises into the filler neck. If the tank is overfilled, heat may cause the fuel to expand and overflow through the vents in the tank cap.
 - Wipe off any spilled gasoline immediately.
- To prevent fire hazard:
 - Keep the engine at least 1 m (3.3 ft) away from buildings, obstructions and other burnable objects.
 - Do not place flammable objects close to the engine.
 - Do not expose combustible materials to the engine exhaust.
 - Do not use the engine on any forest covered, bush covered or grass covered unimproved land unless spark arrester is installed on the muffler.
- To avoid getting an electric shock, do not touch spark plug, plug cap or spark plug lead during engine running.
- To avoid a serious burn, do not touch a hot engine or muffler. The engine becomes hot during operation. Before you service or remove parts, stop engine and allow the engine to cool.
- Do not place hands or feet near moving or rotating parts.
- Do not run engine at excessive speeds. This may result in injury.
- Always remove the spark plug lead from spark plug when servicing the engine to prevent accidental starting.

EMISSIONS CONTROL INFORMATION

Fuel Information

THIS ENGINE IS CERTIFIED TO OPERATE ON UNLEADED REGULAR GRADE GASOLINE ONLY. A minimum of 87 octane of the antiknock index is recommended. The antiknock index is posted on service station pumps in the U.S.A.

Emissions Control Information

To protect the environment in which we all live, Kawasaki has incorporated an exhaust emissions control system in compliance with applicable regulations of the United States Environmental Protection Agency and the California Air Resources Board. Additionally Kawasaki has incorporated an evaporative emission control system in compliance with applicable regulations of California Air Resource Board. Also, depending on when your engine was produced, it may have an assigned emissions durability period. * See below for the engine emissions durability period that may apply to your engine.

Exhaust Emission Control System

The exhaust emission control system applied to this engine consists of a catalytic converter, a carburetor and an ignition system having optimum ignition timing characteristics. The carburetor system has been calibrated to provide lean air/fuel mixture characteristics and optimum fuel economy with a suitable air cleaner and exhaust system.

A sealed-type crankcase emission control system is also used to eliminate blow-by gasses. The blow-by gasses are led to a breather chamber through the crankcase and from there to the air cleaner.

Evaporative Emission Control System

The evaporative emission control system for this engine consists of low permeation fuel hoses, fuel tank and fuel tank cap.

Engine Emissions Compliance Period

California

Engine greater than 80cc and less than 225cc

Model Year - 2007 and later

Durability Period - 500 hours

All Other States

Engine 100 cc – 225 cc

Model Year - 2007 and later

Durability Period - 500 hours (Category A)

*** If your engine has an assigned emissions durability period it will be located on the certification label attached to the engine (IMPORTANT ENGINE INFORMATION).**

High Altitude Performance Adjustment Information

To improve the EMISSIONS CONTROL PERFORMANCE of engines operated above 3,300 feet (1,000 meters), Kawasaki recommends the following Environmental Protection Agency (EPA) and the California Air Resources Board (CARB) approved modifications.

NOTE

○ *When properly performed, these specified modifications only are not considered to be emissions system "tampering" and engine performance is generally unchanged as a result.*

Installation Instructions:

High altitude adjustment requires replacement of carburetor main jets. Installation of these optional parts may be performed by an authorized Kawasaki dealer, or the consumer, following repair recommendations specified in the appropriate Kawasaki Service Bulletin.

Maintenance and Warranty

Proper maintenance is necessary to ensure that your engine will continue to have low emission levels. This Owner's Manual contains those maintenance recommendations for your engine. Those items identified by the Periodic Maintenance Chart are necessary to ensure compliance with the applicable standards.

As the owner of the engine, you have the responsibility to make sure that the recommended maintenance is carried out according to the instructions in this Owner's Manual at your own expense.

The Kawasaki Limited Emission Control System Warranty requires that you return your engine to an authorized Kawasaki dealer for remedy under warranty. Please read the warranty carefully, and keep it valid by complying with the owner's obligations it contains.

Tampering with Emission Control System Prohibited

Federal law and California State law prohibit the following acts or the causing thereof: (1) the removal or rendering inoperative by any person other than for purposes of maintenance, repair, or replacement, of any device or element of design incorporated into any new engine for the purposes of emission control prior to its sale or delivery to the ultimate purchaser or while it is in use, or (2) the use of the engine after such device or element of design has been removed or rendered inoperative by any person.

Among those acts presumed to constitute tampering are the acts listed below:

Do not tamper with the original emission related parts:

1. Exhaust emission related parts

- Carburetor and internal parts
- Spark Plug
- Magneto or electronic ignition system
- Fuel filter element
- Air cleaner element
- Crankcase
- Cylinder head
- Breather chamber and internal parts
- Intake pipe and tube
- Muffler or any internal portion of the muffler

2. Evaporative emission related parts

- Fuel hoses
- Fuel tank
- Fuel tank cap

GENERAL INFORMATION

Location of Safety Related Labels

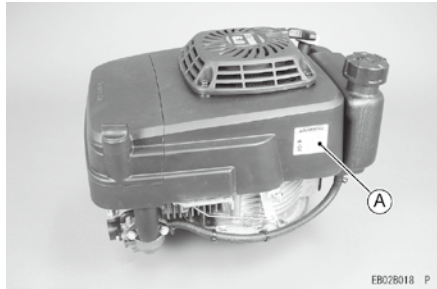

A. Warning Label

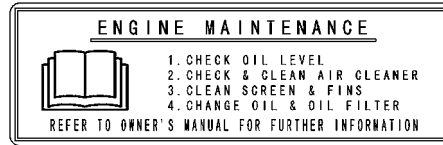

FD790002 S

Engine Serial Number

The engine serial number is your only means of identifying your particular engine from others of the same model type.

This engine serial number shown on the label is needed by your dealer when ordering parts.

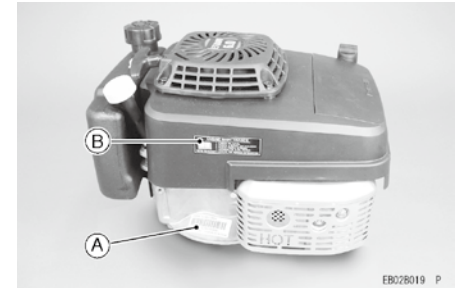

A. Engine Serial Number Label

B. Engine Maintenance Label

Location of Parts

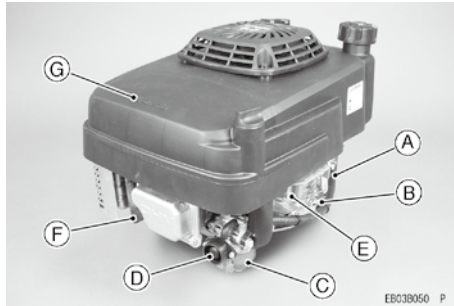

- A. Fuel Tube** **E. Control Panel**
B. Oil Drain Plug **F. Spark Plug Cap/Spark Plug**
C. Carburetor **G. Air Cleaner**
D. Priming Pump (if equipped)

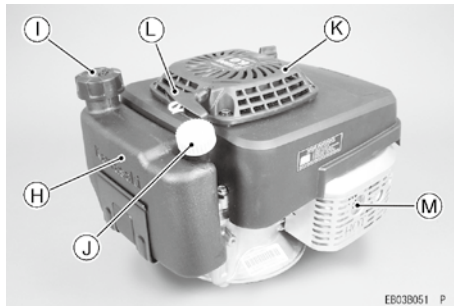

- H. Fuel Tank** **L. Recoil Starter Grip**
I. Fuel Tank Cap **M. Muffler**
J. Oil Gauge/Filler Cap
K. Recoil Starter

Fuel Tank Capacity

1.8 L (0.48 u.s.gal)

Engine Oil Capacity

0.65 L (0.69 u.s.qt)

Tune-up Specifications

Item	Specification
Valve Clearance	IN 0.12 mm (0.005 in.)
	EX 0.12 mm (0.005 in.)
Ignition Timing	Unadjustable
High Idle Speed	3200 r/min (rpm)
Low Idle Speed	1550 r/min (rpm)
Spark Plug Gap	0.7 ~ 0.8 mm (0.028 ~ 0.032 in.)
Other Specifications	NO OTHER ADJUSTMENT NEEDED

NOTE

- *High and Low idle speeds may vary depending on the equipment on which the engine is used. Refer to the equipment specification.*

FUEL AND OIL RECOMMENDATIONS

Fuel

Use only clean, fresh, unleaded regular grade gasoline.

Octane Rating

The octane rating of a gasoline is a measure of its resistance to "knocking". Use a minimum of 87 octane of the antiknock index is recommended. The antiknock index is posted on service station pumps.

NOTE

- If "knocking or pinging" occurs, use a different brand of gasoline or higher octane rating.

CAUTION

Do not mix oil with gasoline.

⚠ WARNING

Gasoline is extremely flammable and can be explosive under certain conditions. Do not smoke. Make sure the area is well ventilated and free from any source of flames or sparks; this includes any appliance with a pilot light. Never fill the tank so the fuel level rises into the filler neck. If the tank is overfilled, heat may cause the fuel to expand and overflow through the vents in the tank cap.

⚠ WARNING

After refueling, make sure the tank cap is closed securely. If gasoline is spilled on the fuel tank wipe it off immediately.

Engine Oil

The following engine oils are recommended.

API Service Classification : SF, SG, SH, or SJ.

Oil Viscosity

Choose the viscosity according to the temperature as follows:

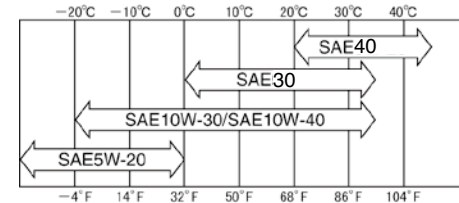

NOTE

- Using multi grade oils (5W-20, 10W-30, and 10W-40) will increase oil consumption. Check oil level more frequently when using them.

PREPARATION

Fuel

- Level the engine (equipment) before fueling.
- Remove the fuel tank cap.
- Slowly pour fuel into the fuel tank to bottom (B) of the filler (A).

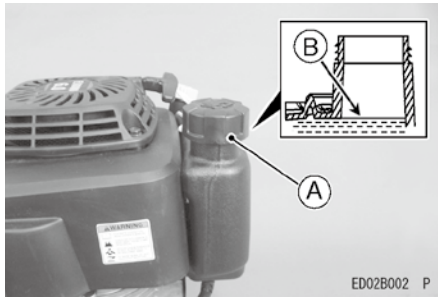

WARNING

Do not over fill the fuel tank, fill only to bottom (B) of the filler (A) to prevent spill out of the fuel from the tank cap.

Fuel Tank Capacity

1.8 L (0.48 us.gal)

- Close the tank cap securely by turning it clockwise as far as it will go.

Engine Oil

Check the engine oil level daily before starting the engine otherwise shortage of the engine oil may cause serious damage to the engine such as seizure.

- Place the engine (equipment) on level surface. Clean area around the oil gauge before removing it.
- Remove the oil gauge (A) and wipe it with clean cloth.
- Pour the oil slowly to "FULL" mark on the oil gauge.
- Insert the oil gauge into the oil filler (B) WITHOUT SCREWING IT IN.
- Remove the oil gauge to check the oil level. Level should be between "ADD" and "FULL" marks. Do not overfill.
- Install and tighten the oil gauge.

Engine Oil Capacity

0.65 L (0.69 us.qt)

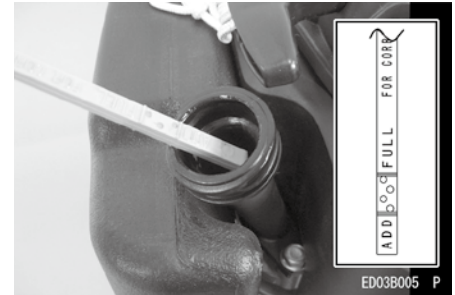

CAUTION

The engine is shipped without engine oil.

STARTING

Starting Engine

For Blade brake clutch Engine

- Move the throttle lever (A) on the equipment to "choke mark" (CHOKE) position.

NOTE

- When the engine is already warm or on hot days, the throttle lever position is halfway (between "Rabbit mark" (FAST) and "turtle mark" (SLOW) position).

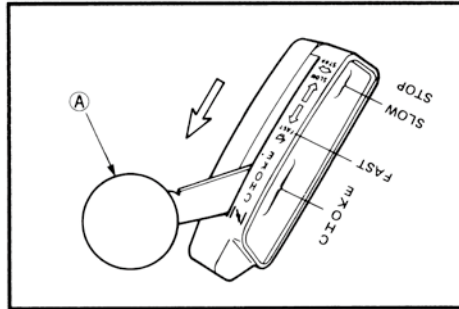

A. Throttle Lever

- Slowly push the priming pump (A) one time. If the engine can not start, push it one more time.

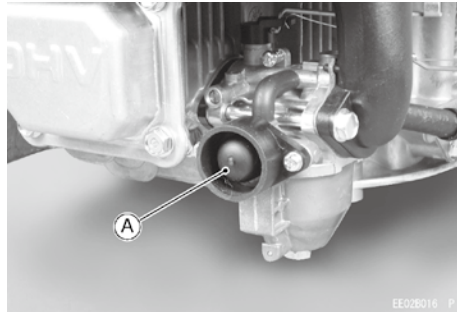

A. Priming Pump

- Pull the recoil starter grip (A) slowly until you feel compression, then pull the recoil starter grip all the way.



A. Recoil Starter Grip
pull in the direction of arrow

CAUTION

DO NOT pull the recoil starter grip out of the end. **DO NOT** let the recoil starter grip snap back itself. This may cause damage to the recoil starter assembly.

For Brake pad system Engine

Upon releasing the brake control lever on the equipment, the cutting blade and the engine will stop automatically. Therefore, the brake control lever must be held against the handle while the engine is started and running.

- Move the throttle lever (A) on the equipment to "choke mark" (CHOKE) position

NOTE

- *When the engine is already warm or on hot days, the throttle lever is halfway position (between "Rabbit mark" and "turtle mark" position).*
- Hold the brake control lever (B) on the equipment against the handle (C) on the equipment.

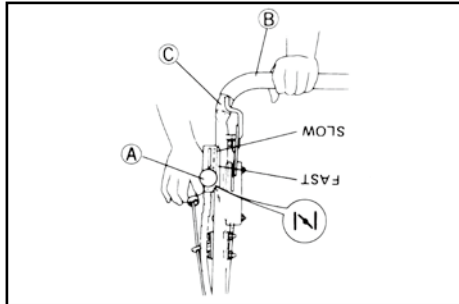

- A. Throttle Lever
- B. Brake Control Lever
- C. Handle

- Pull the recoil starter grip (A) slowly until you feel compression, then pull fast and steady.

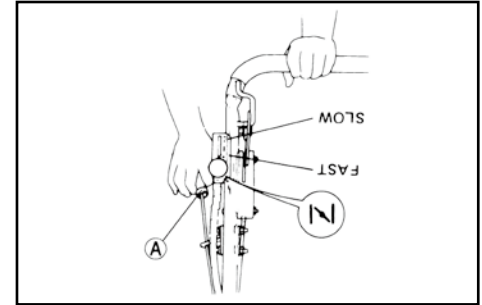

A. Recoil Starter Grip

CAUTION

DO NOT pull the recoil starter grip out of the end. **DO NOT** let the recoil starter grip snap back itself. This may cause damage to the recoil starter assembly.

WARMING UP

Warming up

CAUTION

Allow engine to warm up before loading. This will allow oil to reach all the engine parts, and the piston clearance to reach design specification, before the engine is ready for loading.

- After engine starts, move the throttle lever on the equipment to between "Rabbit mark" (FAST) and "turtle mark" (SLOW) position. To warm up the engine, run it for a few minutes.

OPERATING

Engine Inclination

This engine will operate continuously at angles up to 30° in any direction.

Refer to the operating instructions of the equipment this engine powers. Because of equipment design or application, there may be more stringent restrictions regarding the angle of operation.

CAUTION

Do not operate this engine continuously at angles exceeding 30° in any direction. Engine damage could result from insufficient lubrication.

STOPPING

Stopping Engine

For Brake brake clutch Engine

- Move the throttle lever (A) on the equipment to "turtle mark" (SLOW) position. Keep on running at idling speed for about one minute.

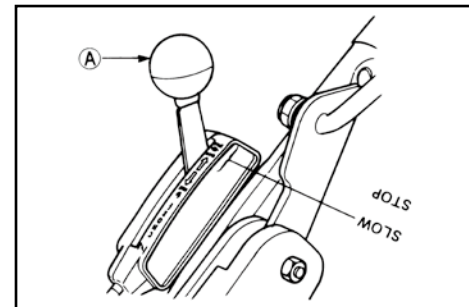

A. Throttle Lever

- Move the throttle lever to "STOP" position to turn ignition off.

ADJUSTMENT

For Brake pad system Engine

- Release the brake control lever (A) on the equipment from the handle (B) on the equipment to stop the engine and the blade.

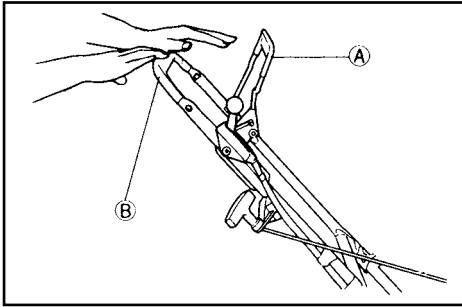

A. Brake Control Lever
B. Handle

Engine Speed Adjustment

NOTE

- *Do not tamper with the governor setting or the carburetor setting to increase the engine speed. Each carburetor is adjusted at the factory with either a cap or stop plate installed on the mixture screw. Any adjustments must be performed an authorized Kawasaki dealer.*

MAINTENANCE

Maintenance, replacement or repair of the emission control devices and systems may be performed by any nonroad engine repair establishment or individual.

Periodic Maintenance Chart



WARNING

Always remove the spark plug cap from spark plug when servicing the engine to prevent accidental starting.

MAINTENANCE	INTERVAL						
	Daily	First 8 hr.	Every 25 hr.	Every 50 hr.	Every 100 hr.	Every 200 hr.	Every 300 hr.
Check oil level and add engine oil	●						
Check for loose or lost nuts and screws	●						
Check for fuel and oil leakage	●						
Check for brake control lever function	●						
Check or clean recoil starter and air intake screen	●						
Tighten nuts and screws			●First		●		
★ Clean air cleaner foam element			●				
★ Clean air cleaner paper element					●		
Change engine oil (without oil filter)		●		●			
Change engine oil (with oil filter)		●			●		
Clean and regap spark plug					●		
Change oil filter						●	
★ Replace air cleaner paper element							●
★ Clean cylinder and cylinder head fins							●
K Clean combustion chamber							●
K Check and adjust valve clearance							●
K Clean and lap valve seating surface							●

Note: The service intervals can be used as a guide. Service should be performed more frequently as necessary by operating condition.

★: Service more frequently under dusty conditions.

K: Service to be performed by an authorized Kawasaki dealer.

Oil Level Check

Check oil level daily and before each time of operation. Be sure oil level is maintained. See PREPARATION chapter.

Oil Change

WARNING

Hot engine oil can cause severe burns. Allow engine temperature to drop from hot to warm level before draining and handling oil.

Change oil after first 8 hours of operation. Thereafter change oil every 50 hours.

- Run the engine to warm oil.
- Be sure the engine (equipment) is level.
- Stop the engine.
- Remove the oil drain plug (A) on side of the engine or on bottom of the engine to drain oil into suitable container (B) while the engine is warm.

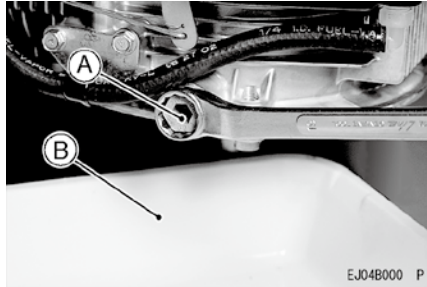

A. Oil Drain Plug (On side of engine)
B. Container

- Reinstall the oil drain plug.
- Remove oil gauge and refill with new oil (See FUEL AND OIL RECOMMENDATIONS chapter).
- Check the oil level (See PREPARATION chapter).

WARNING

Engine oil is a toxic substance. Dispose of used oil properly. Contact your local authorities for approved disposal methods or possible recycling.

Oil Filter Change (if equipped)

- Change the oil filter every 200 hours of operation.

⚠ WARNING

Stop the engine and be careful with hot oil drained.

- Drain engine oil to suitable containers.

CAUTION

Before removing the oil filter, place suitable container under filter connection.

- Rotate the oil filter (A) counter-clockwise to remove it.
- Apply a thin film of clean engine oil on the seal of the new filter.
- Install new filter rotating it clockwise until the seal contacts mounting surface (B). Then rotate filter 3/4 turn more by hand.
- Supply engine oil as specified.
- Run the engine for about 3 minutes, stop engine, and check oil leakage around the filter.
- Add oil to compensate oil level down due to oil filter capacity (see PREPARATION for oil level check).

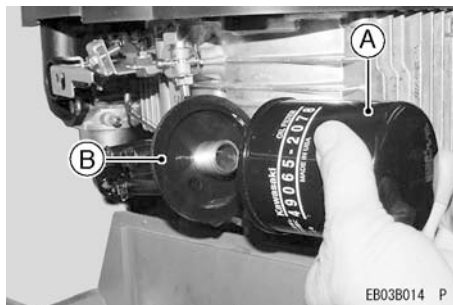

A. Oil Filter

B. Mounting Surface

Cooling System Cleaning

Before each use, check that the recoil starter (A) is free from grass and debris and clean to prevent engine overheating.

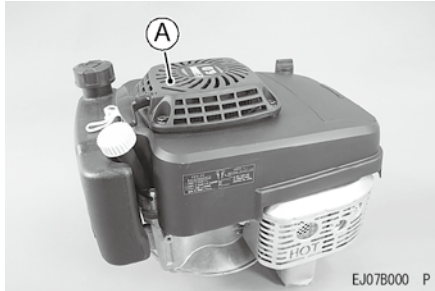

A. Recoil Starter

Air Cleaner Service

CAUTION

To prevent excessive engine wear, do not run the engine with the air cleaner removed.

⚠ WARNING

Clean the elements in a well ventilated area and take care that there are no sparks or flame anywhere near the working area, this includes any appliance with a pilot light.

Do not use gasoline or low flash-point solvents to clean the element. A fire or explosion could result.

- Loosen nut (A) and remove air cleaner case (B) from air cleaner body (C).

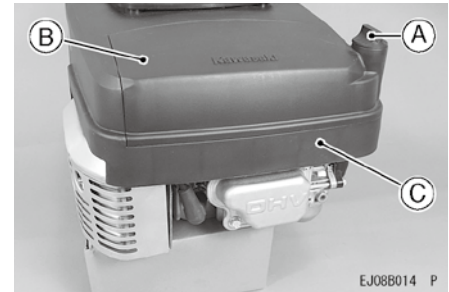

- A. Screw
- B. Air Cleaner Case
- C. Air Cleaner body

- Remove the air cleaner elements (A) (the paper element and foam element) from the air cleaner body.

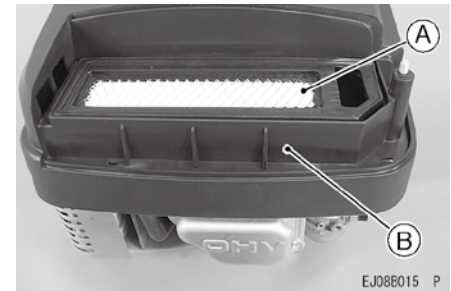

- A. Air Cleaner Elements
- B. Air Cleaner Body

Foam Element (A)

Clean the foam element every 25 hours.

- Wash the element in detergent and water, and dry it thoroughly.

CAUTION

Do not oil foam element.

Paper Element (B)

Clean the paper element every 100 hours.

- Clean the element by tapping gently to remove dust. If very dirty, replace the element with a new one.
- Replace with a new paper-element yearly or every 300 hours.

CAUTION

**Do not wash paper-element.
Do not use pressurized air to clean
or dry paper element.**

NOTE

- *Operating in a dusty condition may require more frequent maintenance than above.*

- Reinstall the foam element and then the paper element on the air cleaner body.

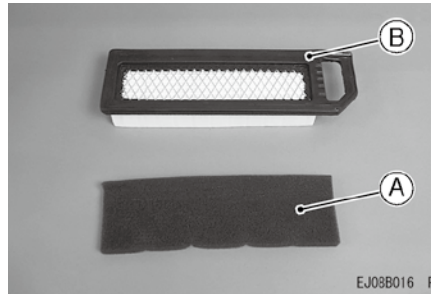

- A. Foam Element
- B. Paper Element

CAUTION

After servicing the air cleaner, be sure all the removed parts are reinstalled properly in place. Failure to secure fastening of the air cleaner case with the air cleaner body may cause dirt or other foreign materials to enter the engine, while it is running, through the air cleaner, resulting in engine troubles or failures.

Spark Plug Service

WARNING

Hot engine components can cause severe burns. Stop engine and allow it to cool before checking spark plug.

Clean or replace the spark plug and reset the gap (A) every 100 hours of operation.

- Disconnect the spark plug cap from spark plug and remove the spark plug.
- Clean the electrodes (B) by scraping or with a wire brush to remove carbon deposits.
- Inspect for cracked porcelain or other wear and damage. Replace the spark plug with a new one if necessary.
- Check the spark plug gap and reset it if necessary. The gap must be between 0.7 and 0.8 mm (0.028 and 0.032"). To change the gap, bend only the side-electrode, using a spark plug tool.
- Install and tighten the spark plug to 22 N.m (2.2 kgf.m, 16 ft.lb).
- Fit the spark plug cap on the spark plug securely.
- Pull up the spark plug cap lightly to make sure of the installation of the spark plug cap.

RECOMMENDED SPARK PLUG

NGK.....BPR5ES

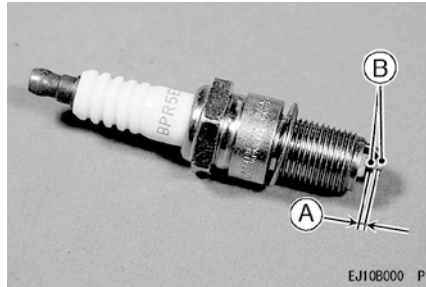

A. Spark Plug Gap B. Electrodes

CAUTION

Be sure to use the same type of spark plug for change. Resistor spark plug is required in some area by local law.

STORAGE

Engine to be stored over 30 days should be completely drained of fuel (gasoline) to prevent gum deposits forming on essential carburetor parts and the fuel system.

⚠ WARNING

Gasoline is extremely flammable and can be explosive under certain conditions.

Drain gasoline before storing the equipment for extended periods. Drain gasoline in a well ventilated area away from any source of flame or sparks, including any appliances with a pilot light. Store gasoline in an approved container in safe location.

- Remove the spark plug cap from spark plug to prevent accidental starting the engine.
- Empty the fuel from the fuel tank with a pump or siphon.
- Fit the plug cap on the spark plug securely.
- Start and run the engine at idle speed to use up the fuel in the fuel system.

⚠ WARNING

Before maintaining engine, stop the engine and allow it to cool.

- Remove the spark plug and pour approx. 1~2 mL (0.06~0.1 cu.in) of new engine oil through the plug hole (A), slowly pull the recoil starter grip several times and reinstall the spark plug.

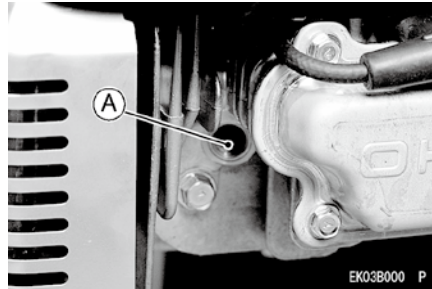

A. Spark Plug Hole

- Slowly pull the recoil starter grip until you feel compression and leave it there.
- Clean every part of the engine.
- After period of storage, change engine oil. (Refer to "Oil Change" section in "MAINTENANCE" chapter).

⚠ WARNING

Gasoline is a toxic substance. Dispose of gasoline properly. Contact your local authorities for approved disposal methods.

TROUBLESHOOTING GUIDE

If the engine malfunctions, carefully examine the symptoms and the operating conditions, and use the table below as a guide to troubleshooting.

Symptom		Probable Cause	Remedy
Engine won't start or output is low	Insufficient compression	Faulty piston, cylinder, piston ring, and cylinder head gasket	K
		Faulty valves	
		Loose spark plug	Tighten properly
		Loose cylinder head bolts	
	No fuel to combustion chamber	No fuel in fuel tank	Fill fuel tank
		Blocked fuel tube	Clean
		Blocked air vent in fuel tank cap	
		Faulty carburetor	K
	Spark plug fouled by fuel	Over-rich fuel/air mixture	Slowly pull the recoil starter grip with spark plug removed to discharge excess fuel. Clean spark plug.
		Clogged air cleaner	Clean
		Faulty carburetor	K
		Incorrect grade/type of fuel	Change gasoline
		Water in fuel	
	No spark or weak spark	Faulty spark plug	Replace spark plug
Faulty ignition coil		K	
Faulty engine switch		K	
Low output	Engine overheats	Clogged air cleaner	Clean
		Recoil starter or cooling air path clogged with dirt	
		Insufficient engine oil	Replenish or change oil
		Carbon built-up in combustion chamber	K
		Poor ventilation around engine	Select a better location
	Engine speed won't increase	Faulty governor	K

K: Service to be performed by an authorized Kawasaki dealer.

ENVIRONMENTAL PROTECTION

To protect our environment, properly discard used batteries, engine oil, gasoline, coolant, or other components that you might dispose of in the future.

Consult your authorized Kawasaki dealer or local environmental waste agency for their proper disposal procedure.

SPECIFICATIONS

Type of engine	Air-cooled, 4-stroke OHV, Single cylinder, gasoline engine
Bore x Stroke	65 x 54 mm(2.6 x 2.1 in.)
Displacement	179 mL (10.9 cu.in)
Ignition system	Solid-state ignition
Starting system	Recoil starter
Dry weight	17.0 kg (37.49 lb)

Specifications are subject to change without notice



WARNING:



The engine exhaust from this product contains chemicals known to the State of California to cause cancer, birth defects or other reproductive harm.

Engine oil is a toxic substance. Dispose of used oil properly. Contact your local authorities for approved disposal methods or possible recycling.

For repair/warranty assistance please contact your local Kawasaki Authorized Dealer, email kawpower-website@kmc-usa.com or call toll-free 1-877-364-6404

Gasoline is a toxic substance. Dispose of gasoline properly. Contact your local authorities for approved disposal methods.

Kawasaki

Engines