

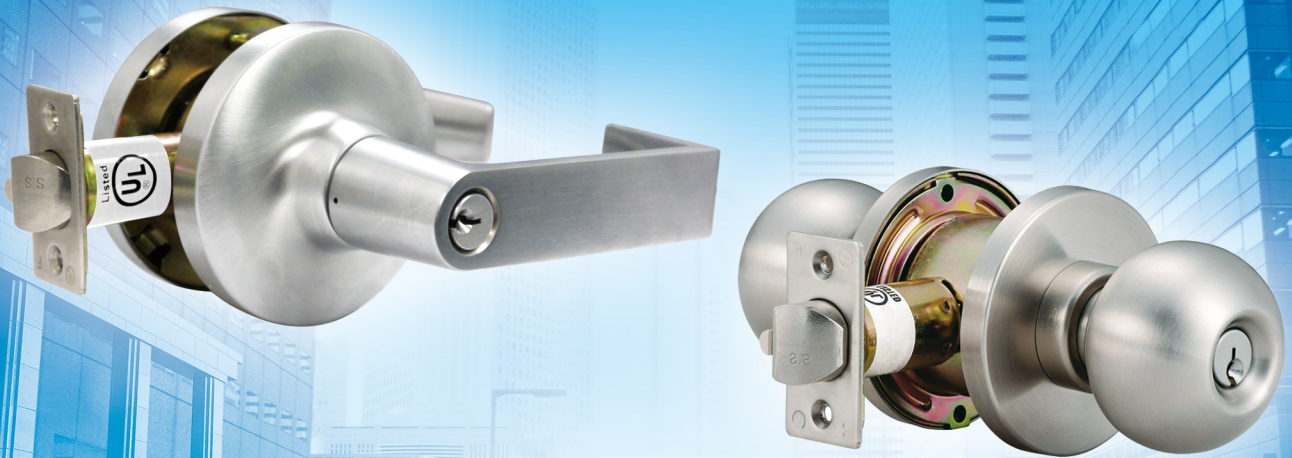

CL/CK Series

GRADE 1 HEAVY DUTY CYLINDRICAL LOCKS



Division 8

ANSI/BHMA 156.2 GRADE 1 SPECIFICATION



10 YEAR WARRANTY



UNISON HARDWARE, INC.

www.inoxproducts.com

Version: 2015.10

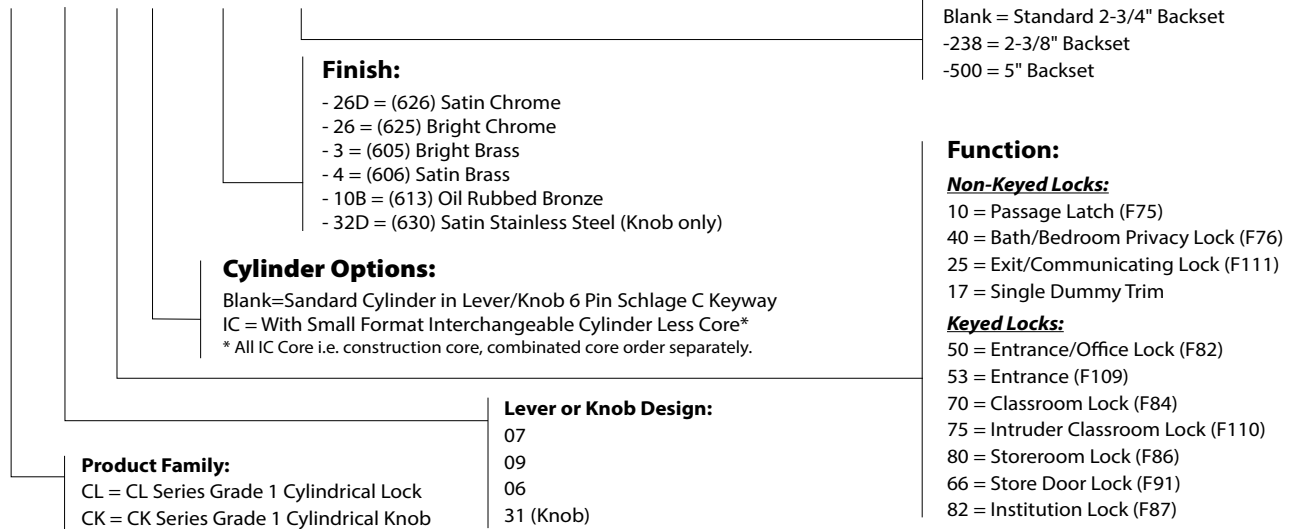

TABLE OF CONTENTS

| | |
|--|--------|
| How to order..... | Page 1 |
| CL/CK Cylindrical Locksets | Page 2 |
| CL/CK Series Features and Specifications | Page 3 |
| Knob and Lever Designs | Page 4 |
| Functions | Page 5 |
| Latches and Strike Plates | Page 6 |
| Cylinders and Keying Services | Page 7 |

How to Order

Product Identification

CL 07 50 IC -26D -238

INOX[®] CL Cylindrical Lock CROSS REFERENCES

| ANSI No. Grade 1 | Function | INOX [®] | Dorma | Schlage | Hager | Cal-Royal |
|------------------|--------------------|-------------------|-------|---------|-------|-----------|
| F75 | Passage | CL10 | CL710 | ND10S | 3410 | GN-30 |
| F76 | Privacy | CL40 | CL840 | ND40S | 3440 | CGN-20 |
| F111 | Exit/Communicating | CL25 | - | ND25 | - | - |
| F109 | Entrance | CL53 | CL853 | ND53PD | 3453 | CGN-00 |
| F84 | Classroom | CL70 | CL870 | ND70PD | 3470 | CGN-03 |
| F110 | Intruder Classroom | CL75 | - | - | 3495 | CGN-07 |
| F86 | Storeroom | CL80 | CL880 | ND80PD | 3480 | CGN-04 |
| F91 | Store Door | CL66 | - | ND66 | - | CGN-02 |
| F87 | Institution | CL82 | CL882 | ND82PD | - | CGN-09 |
| - | Dummy | CL17 | CL801 | ND170 | 3417 | GN-40 |

INOX[®] CK Cylindrical Lock CROSS REFERENCES

| ANSI No. Grade 1 | Function | INOX [®] | Dorma | Schlage | Hager | Cal-Royal |
|------------------|--------------------|-------------------|-------|---------|-------|-----------|
| F75 | Passage | CK10 | CK810 | D10S | 3410 | GRB-30 |
| F76 | Privacy | CK40 | CK840 | D40S | 3440 | GRB-20 |
| F111 | Exit/Communicating | CK25 | - | D25D | - | - |
| F109 | Entrance | CK53 | CK853 | D53PD | 3453 | GRB-00 |
| F84 | Classroom | CK70 | CK870 | D70PD | 3470 | GRB-03 |
| F110 | Intruder Classroom | CK75 | - | - | - | - |
| F86 | Storeroom | CK80 | CK880 | D80PD | 3480 | GRB-05 |
| F91 | Store Door | CL66 | - | - | - | GRB-02 |
| F87 | Institution | CK82 | CK882 | D82PD | - | GRB-09 |
| - | Dummy | CK17 | CK801 | D170 | 3417 | GRB-40 |

CL Series Grade 1 Cylindrical Lock

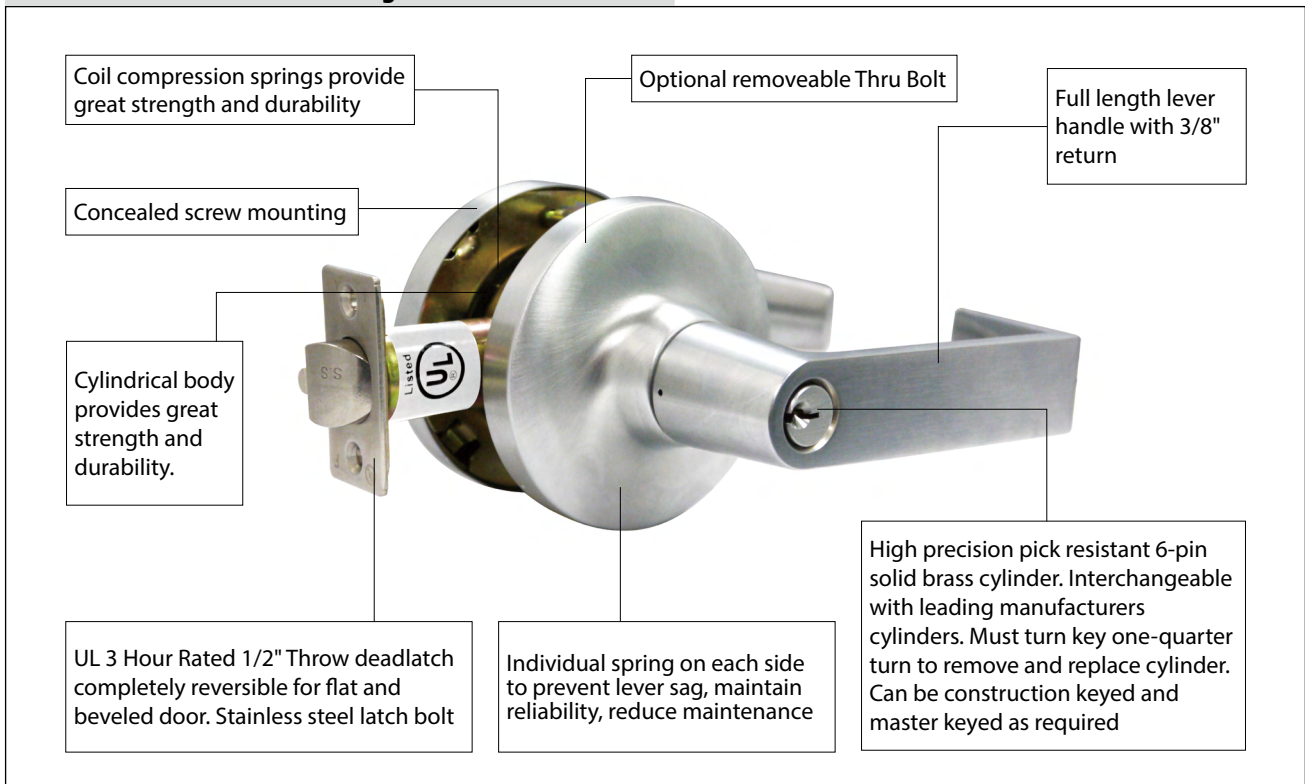

CK Series Grade 1 Cylindrical Knob

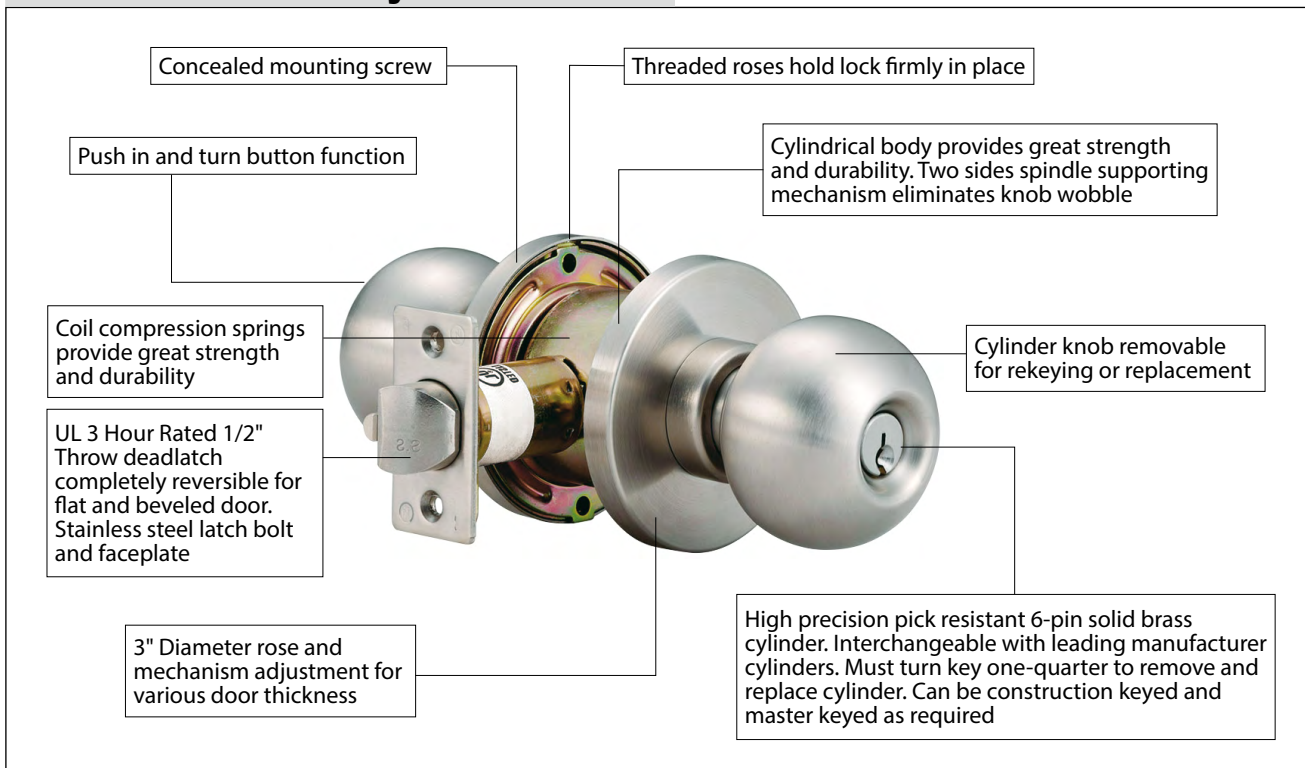

CL Lockset / CK Knobset Grade 1

Commercial Cylindrical Locks

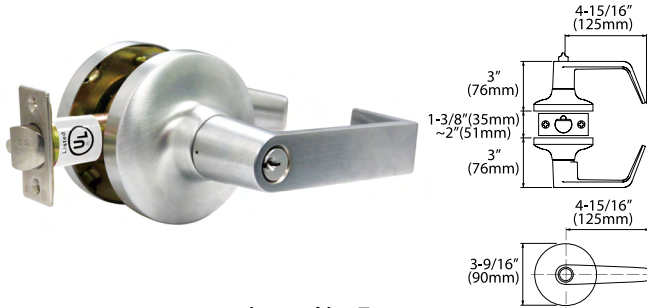

Lever No. 7

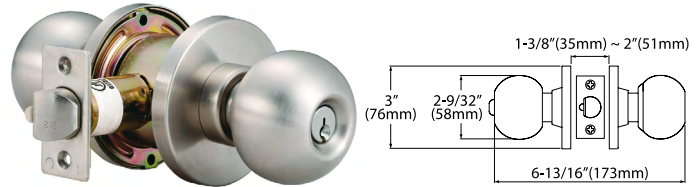

Knob No. 31

Specifications

- **Door Thickness:** 1-3/8" (35mm) ~2" (51mm) doors standard.
- **Door Prep:** Crossbore 2-1/8" (54mm), Edgebore 1" (25mm), Latch face 2-1/4" (57mm) x 1-1/8" (28.6mm).
- **Backset:** 2-3/4" (70mm) standard. 2-3/8" (60mm) and 5" (127mm) optional.
- **Cylinder:** 6-pin anti-pick, solid brass cylinder.
- **Keys:** Two (2) keys per lock. Schlage C keyway. Keyed-Different standard. Keyed-Alike, Construction key, Master key suite, or other keyway available by special order.
- **Handing:** Non-handed.
- **Trim:** Solid zinc diecast levers. 55° lever rotation for full latch retraction.
- **Clutch Function (CL):** Outside lever free wheeling while locked to prevent vandalism.
- **Rose:** 3-9/16" (90mm) diameter for CL Rose, 3" (76mm) diameter for CK Rose. Brass roses. Concealed screws. Threaded interior and exterior roses. Removable thru bolts.
- **Latchbolt:** 1/2" (12.7mm) throw, stainless steel 3 hour fire rated latchbolt. Reversible for flat and beveled doors.
- **Faceplate:** 2-1/4" (57mm) x 1-1/8" (28.6mm) square corner standard. Stainless steel or brass faceplate.
- **Strike:** ANSI curved lip strike 4-7/8" (124mm) x 1-1/4" (32mm) x 1-1/4" (32mm) lip to center standard. Full lip strike or T strike available.

Warranty

10 Year Warranty

Finishes

- Stocking: US26D (626) Satin Chrome
US10B (613) Oil Rubbed Bronze
- Special Order:
US26 (625) Bright Chrome
US3 (605) Bright Brass
US4 (606) Satin Brass
US32D (630) Satin Stainless Steel (Knob only)

Functions**Keyed Locks:**

- Entrance/Office Lock (F82)
- Entrance (F109)
- Classroom Lock (F84)
- Intruder Classroom Lock (F110)
- Storeroom Lock (F86)
- Store Door Lock (F91)
- Institution Lock (F87)

Non-Keyed Locks:

- Passage Latch (F75)
- Bath/Bedroom Privacy Lock (F76)
- Exit/Communicating Lock (F111)
- Single Dummy Trim

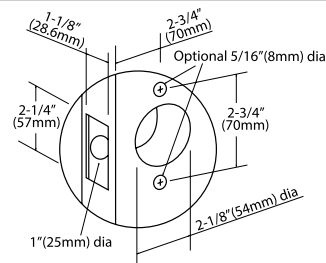
Door Preparation**Code Compliance**

- ANSI A156.2 Grade 1, UL 10C and UBC 7.2 for positive pressure.
- ANSI A117.1 ADA Barrier-free Accessibility
- C-UBC California Uniform Builders Code-2001
- NFPA-80 National Fire Protection-1999
- NFPA-101 National Fire Protection-Life Safety-2000

Lever or Knob Designs

Lever Options

07

IN STOCK

09

SPECIAL ORDER

06

SPECIAL ORDER

31 (Knob)

SPECIAL ORDER

Finishes

| IN STOCK | | SPECIAL ORDER | | | |
|----------------------------|---------------------------------|--|----------------------------|--------------------------|-------------------------|
| | | | | | |
| US26D(626) Satin Chrome | US10B(613) Oil Rubbed Bronze | US32D(630) Satin Stainless (Knob Only) | US26(625) Bright Chrome | US3(605) Bright Brass | US4(606) Satin Brass |

Functions

Non Keyed Locks

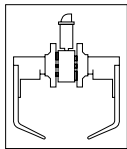

**10 (ANSI: F75)
Passage Latch**

- Both levers are always unlocked from inside and outside

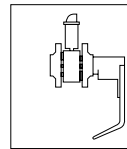

**25 (ANSI: F111)
Exit/Communicating Lock**

- Inside lever is always unlocked
- Blank plate outside
- Inside lever is always free for emergency exit.

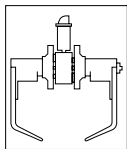

**40 (ANSI: F76)
Bath/Bedroom Privacy Lock**

- Outside lever is locked by push button inside
- Outside lever is unlocked by emergency release outside, or rotating inside lever or closing door
- Inside lever is always free providing emergency exit

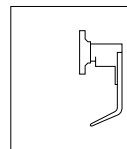

**17
Single Dummy Trim**

- Single dummy trim for one side

Keyed Locks

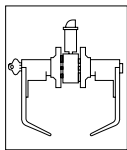

**50 (ANSI: F82)
Entrance/Office Lock**

- Push button locks outside lever until unlocked by key or turning inside lever.
- Key outside releases push button, unlocking outside lever.
- Operating inside lever release push button, unlocking outside lever.
- Inside lever is always free providing emergency exit.

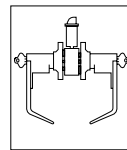

**75 (ANSI: F110)
Intruder Classroom Lock**

- The outside lever is locked or unlocked by key from either side.
- When unlocked, the lockset works as a passage set
- When locked, key required from either outside or inside to unlock the lockset
- The inside lever is always unlocked providing emergency exit

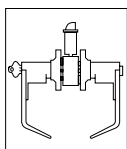

**53 (ANSI: F109)
Entrance Lock**

- Push and thumb-turn button keep outside lever locked. Key is always required to unlock the outside lever until button is reset.
- Push button only locks outside lever, until it is unlocked by key or by turning inside lever.
- Key release outside lever and push button inside, except when inside button is pushed and turned to keep outside lever locked.
- Inside lever always free for emergency exit.

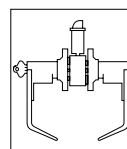

**80 (ANSI: F86)
Storeroom Lock**

- Outside lever is unlocked only while key is turned
- Inside lever is always free providing emergency exit

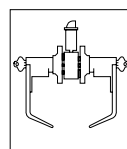

**66 (ANSI: F91)
Store Door Lock**

- Key from either inside or outside locks or unlocks both levers
- When unlocked, latch bolt operates by lever from either side.

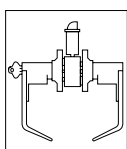

**70 (ANSI: F84)
Classroom Lock**

- The outside lever is locked or unlocked by key
- When unlocked the lockset works as a passage set
- When locked, key required from outside to unlock the lockset
- The inside lever is always unlocked providing emergency exit

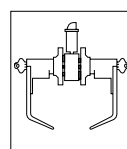

**82 (ANSI: F87)
Institution Lock**

- Both levers are always inoperable
- Entrance by key in lever from either side

Latches

Deadlatches and Spring Latches



LSL06N
2-3/8" Spring Latch
1-1/8" Faceplate
CL/CK Series



LSL06K
2-3/8" Dead Latch
1-1/8" Faceplate
CL/CK Series



LSL07N
2-3/4" Spring Latch
1-1/8" Faceplate
CL/CK Series



LSL07K
2-3/4" Dead Latch
1-1/8" Faceplate
CL/CK Series

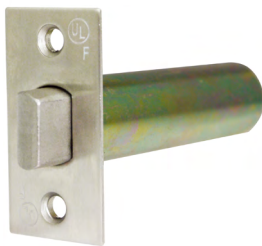

LSL08N
5" Spring Latch
1-1/8" Faceplate
CL/CK Series

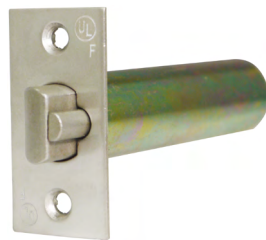

LSL08K
5" Dead Latch
1-1/8" Faceplate
CL/CK Series



LSK-EX15
Extension for 5" Backset

Strikes

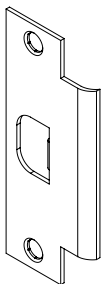

LSR-ASA
ASA Strike (ANSI Standard)
1-1/4"x4-7/8"

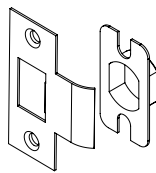

LSR-T1
T-Strike
1-1/8" x 2-3/4"
w/lip 1-1/2" x 1/2"

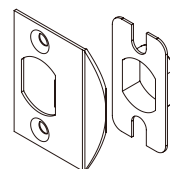

LSR-D1
Full-lip Strike
1-3/4" x 2-1/4"

Standard Cylinder

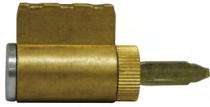
| Illustration | Item Code | Description | ANSI |
|---|------------|---|--------|
|  | CYKB1146SC | Standard Cylinder in Lever or Knob, 6 Pin Schlage C Keyway | E09231 |

Interchangeable Cores Only

- Solid brass plug and housing
- Small Format (SFIC) Core in Best A Keyway
- 6 or 7 pin cores replace Arrow, Best, Falcon
- Construction or Combined Core
- 1 Control key per group/order
- 2 Change keys per Combined Core – A2 System Only
- 1 master key or grand master key included per group/order
- US26D or US4 finish only

| Illustration | Item Code | Description | ANSI |
|---|---------------|--|--------|
|  | CMB-ICBA6-CST | SFIC Core Only, Best A Keyway, 6 Pin, Construction | E09251 |
| | CMB-ICBA6-CMB | SFIC Core Only, Best A Keyway, 6 Pin, Combined | E09251 |
| | CMB-ICBA7-CMB | SFIC Core Only, Best A Keyway, 7 Pin, Combined | E09251 |

Keys

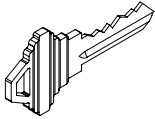
| Illustration | Item Code | Description |
|---|------------------|---|
|  | LSK-6SC-NP | Standard key Schlage C Keyway for 6 Pin, Nickel Plated |
| | LSK01-6SC-NS-DND | DND Nickel Silver Key, Schlage C Keyway for 6 Pin, w/"Do Not Duplicate" |
| | LSK06-BA-CRK | Extra Control Key for IC Core, Best A Keyway |
| | LSK06-BA-MK | Extra Master Key for IC Core, Best A Keyway |
| | LSK06-BA-GMK | Extra Grand Master Key for IC Core, Best A Keyway |

Keying Services

| Description | Item No. |
|--|----------------|
| Service: Key Cut including Key Blank | SV-KYCT |
| Service: Keyed Alike (KA) | SV-KA |
| Service: Keyed Alike Pair | SV-KA2 |
| Service: Keyed Alike Group (Specify Number of Keyed Alike Per Group) | SV-KA (Number) |
| Service: Keyed to Specific Code | SV-KS |
| Service: Master Keying | SV-MK |
| Service: Grand Master Keying with 2 or more Master groups. | SV-GMK |
| Service: Construction Master Keying Service | SV-CMK |
| Service: Great Grand Master Key | SV-GGMK |

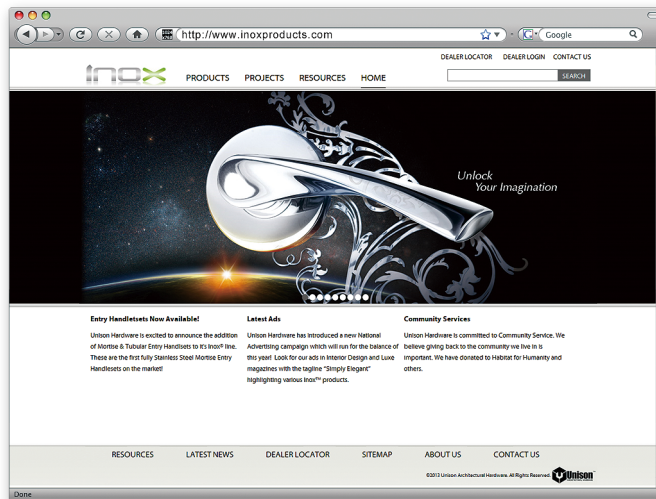

Please visit our website
<http://www.inoxproducts.com>
for more technical and new product information.



Unison Hardware, Inc.

6 Wayne Court, Sacramento, CA 95829, USA

Tel: +1.916.388.1888 Fax: +1.916.388.8322

<http://www.inoxproducts.com>

Email: info@unisonhardware.com